

Amphenol

ACR97B02A 06 18

97B Series

Reverse Bayonet Connectors (MIL-DTL-5015)



Amphenol

Introduction

Amphenol 97B series MIL-DTL-5015 bayonet coupled connectors designed to meet the operating requirements of MIL-DTL-5015. Available in a variety of styles & classes, connectors having features like quick mating bayonet coupling with an audible full mating feature provides resistance to shock & vibration and avoids connector de-coupling in even the most rugged applications.

This series uses the same MIL-DTL-5015 insert patterns and are used in Military applications where specific degrees of environmental protection are required. These connectors are also used in application like Mass Transits, Locomotive & Ground Support applications.

Content	Page
Introduction	1
Connector style	2
General description	3
Electrical data	4
Insert orientations	5
Insert arrangements	6-17
Connector styles	18-34
Back accessory	35
Protective cap	36
Dummy & bulkhead receptacles	37
Crimp contact	38-39
Ordering information	40

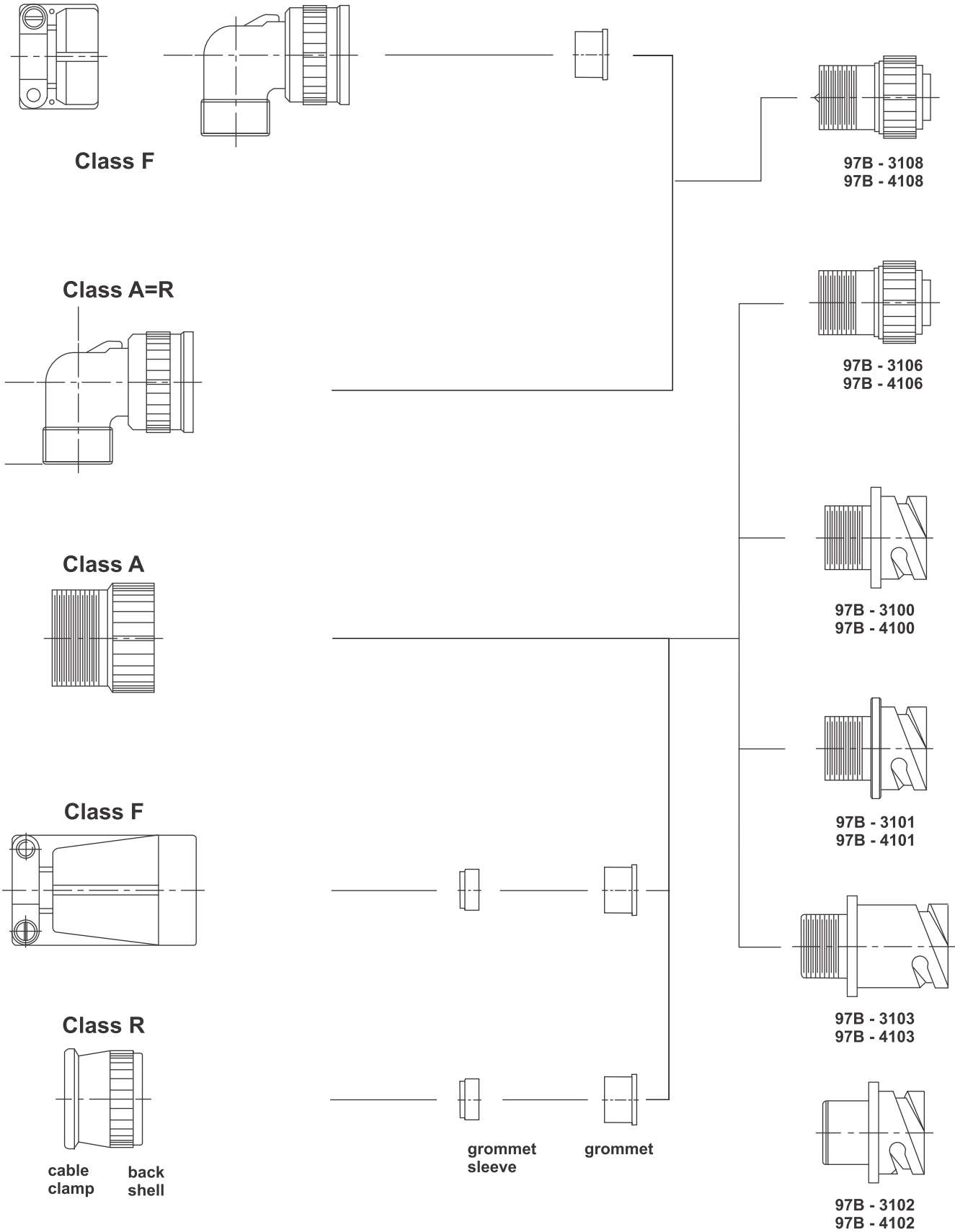

These electrical connectors are designated MS because the interchangeability and operating characteristics are determined by U.S. Military Specifications. These specifications are revised from time to time to incorporate performance requirements dictated by design advances and more stringent requirements of allied equipment. The several designations of MS and 97B connectors meet different requirements of MIL-C-5015. These designations and general descriptions are as follows :

Shell

Shell constructions include solid back shell (A) and environmental resistant (E, F & R). Environmental resistant connectors provide a moisture barrier and assure a positive seal. Shell styles consist of wall type receptacles (3100), cable receptacles (3101), box receptacles (3102), straight plugs (3106) and angle plugs (3108). Shell hardware is manufactured from aluminium alloy and cadmium plated with olive drab chromate finish. This finish has excellent conductivity; it is non-reflecting and corrosion resistant. Black anodised finish and cadmium-free zinc plating with olive drab chromate finish are also available. For details, contact factory.

Contacts

Pin and socket contacts are of brass and generally silver plated. Gold plating is also available. For details contact factory. These contacts are available for solder or crimp termination. Special arrangements of contacts for pre-mating and pre-earth are also available.

Inserts and grommet

Synthetic inserts and grommet manufactured according to MIL-R-3065, offer high dielectric strength and are resistant to oils, gasoline and low temperature. DAP is dimensionally stable, has high arc resistance and high insulation resistance under both humidity and thermal stress.

General description

Plugs are available in A, F and R types. Receptacles are available in A, E, F and R types.

A Solid back shell

Intended for general service usage to provide convenient means of connecting and disconnecting electrical circuits in industrial and military applications.

Environmental resisting

Intended for use where the connector will be subject to heavy condensation and rapid changes in temperature or pressure and/or where the connector is subjected to high vibratory conditions.

E Environmental resisting with grommet seal and strain relief backshell except for 3102 type.

F Environmental resisting with grommet seal, strain relief backshell and front gasket seal for plug type.

R Environmental resisting with grommet seal, shorter and lightweight.

Features for 97B reverse bayonet coupling connectors with MIL-C-5015 insert patterns:

- Quick positive coupling
- Audible and tactile indication of full coupling
- Waterproof
- No lockwiring required
- High shock and vibration capabilities
- Insert available in Neoprene material (alternate inserts materials available upon request)
- Operating temperature range with Neoprene inserts: -55°C to +125°C
- Available in both crimp and solder terminations
- Contacts available in gold and silver plating
- Numerous finishes available
- Zinc alloy plating (cadmium free) available
- Rugged construction; aluminum or stainless steel components
- Intermateable with existing VG95234 connectors
- 500 couplings minimum

Dielectric Strength

Service Rating	Test Voltage Vac rms
Inst.	1000V
A	2000V
D	2800V
E	3500V
B	4500V
C	7000V

Contact Rating

Contact Size	Rated Current	Contact Resistance miliohms
16	13A	3.46
12	23A	1.83
8	46A	0.52
4	80A	0.26
0	150A	0.14

Service Rating

Service Rating	Operating Voltage DC at Sea Level	Operating Voltage AC at Sea Level
Inst.	250V	200V
A	700V	500V
D	1250V	900V
E	1750V	1250V
B	2450V	1750V
C	4200V	3000V

Insert Orientation

To avoid cross-plugging problems in applications requiring the use of more than one connector of the same size and arrangement, alternate insert rotations are available as indicated in the accompanying chart.

As shown in the diagram below, the front face of the pin insert is rotated within the shell in a clockwise direction from the normal shell key. The socket insert would be rotated counterclockwise the same number of degrees with respect to the normal shell key.

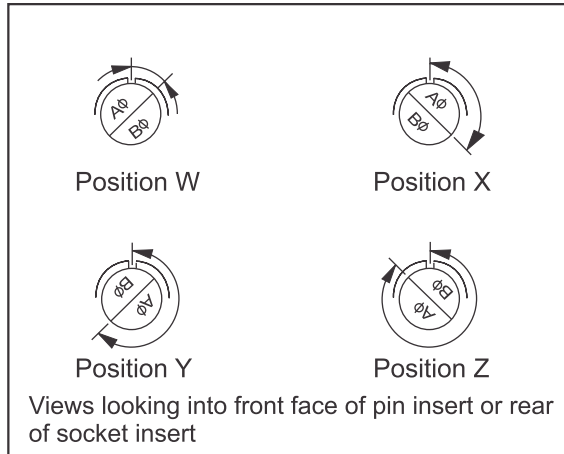

The following insert arrangements have the same alternate insert rotations for W, X, Y and Z which are as below :

Degree			
W	X	Y	Z
80	110	250	280

16-7	20-16	22-18	24-6	28-8	32-1
18-5	20-20	22-19	24-7	28-9	32-3
18-9	20-22	22-21	24-12	28-10	32-4
18-13	22-3	22-24	24-16	28-11	32-6
18-14	22-6	22-25	24-17	28-15	36-1
20-7	22-12	22-29	24-20	28-16	36-7
20-8	22-14	22-34	24-21	28-17	36-8
20-9	22-15	24-3	24-28	28-19	36-13
20-12	22-16	24-4	28-1	28-20	
20-14	22-17	24-5	28-4	28-21	

Insert Arrangement	Degrees			
	W	X	Y	Z
12S-3	70	145	215	290
14S-2	-	120	240	-
14S-5	-	110	-	-
14S-7	90	180	270	-
14S-9	70	145	215	290
16-9	35	110	250	325
16-10	90	180	270	-
16-11	35	110	250	325
16-13	35	110	250	325
16S-1	80	-	-	280
16S-4	35	110	250	325
16S-5	70	145	215	290
16S-6	90	180	270	-
16S-8	-	170	265	-
18-1	70	145	215	290
18-3	35	110	250	325
18-4	35	110	250	325
18-8	70	-	-	290
18-10	-	120	240	-
18-11	-	170	265	-
18-12	80	-	-	280
18-15	-	120	240	-
18-20	90	180	270	-
18-19	-	120	240	-
18-22	70	145	215	290
18-29	90	180	270	-
20-3	70	145	215	290
20-4	45	110	250	-

Insert Arrangement	Degrees			
	W	X	Y	Z
20-6	70	145	215	290
20-15	80	-	-	280
20-17	90	180	270	-
20-18	35	110	250	325
20-19	90	180	270	-
20-21	35	110	250	325
20-23	35	110	250	325
20-24	35	110	250	325
20-27	35	110	250	325
20-29	80	-	-	280
22-1	35	110	250	325
22-2	70	145	215	290
22-4	35	110	250	325
22-5	35	110	250	325
22-8	35	110	250	325
22-9	70	145	215	290
22-10	35	110	250	325
22-11	35	110	250	325
22-13	35	110	250	325
22-20	35	110	250	325
22-22	-	110	250	-
22-23	35	-	250	-
22-27	80	-	250	280
22-28	80	-	-	280
24-2	80	-	-	280
24-9	35	110	250	325
24-10	80	-	-	280
24-11	35	110	250	325

Insert Arrangement	Degrees			
	W	X	Y	Z
24-22	45	110	250	-
24-27	80	-	-	280
28-2	35	110	250	325
28-3	70	145	215	290
28-5	35	110	250	325
28-6	70	145	215	290
28-7	35	110	250	325
28-12	90	180	270	-
28-18	70	145	215	290
28-22	70	145	215	290
32-5	35	110	250	325
32-7	80	125	235	280
32-8	80	125	235	280
32-17	45	110	250	-
36-3	70	145	215	290
36-4	70	145	215	290
36-5	-	120	240	-
36-6	35	110	250	325
36-9	80	125	235	280
36-10	80	125	235	280
36-14	90	180	270	-
36-15	60	125	245	305
36-52	72	216	235	258
40-56	72	144	216	288

Insert Arrangements

Insert Arrangement	Service Rating	Total Cont-acts	Contact Size				
			0	4	8	12	16
10S-2	A	1					1
10SL-3	A	3					3
10SL-4	A	2					2
12S-3	A	2					2
12S-4	D	1					1
12-5	D	1				1	
14S-1	A	3					3
14S-2	Inst	4					4
14S-4	D	1					1
14S-5	Inst	5					5
14S-6	Inst	6					6
14S-7	A	3					3
14S-9	A	2					2
14S-10	Inst	4					4
14S-12	A	3					3
14-3	A	1			1		
14S-A7	A	19	19				
16S-1	A	7					7
16S-3	B	1					1
16S-4	D	2					2
16S-5	A	3					3
16S-6	A	3					3
16S-8	A	5					5
16-2	E	1				1	
16-7	A	3			1		2
16-9	A	4				2	2
16-10	A	3				3	
16-11	A	2				2	
16-12	A	1		1			
16-13	A	2				2	
18-1	A/Inst	10					10
18-3	D	2				2	
18-4	D	4					4
18-5	D	3				2	1
18-06		6				4	2
18-6	D	1		1			
18-7	B	1			1		
18-8	A	8				1	7
18-9	Inst	7				2	5
18-10	A	4				4	
18-11	A	5				5	
18-12	A	6					6
18-13	A	4			1	3	
18-14	A	2		1			1
18-15	A	4				4	
18-16	C	1				1	
18-17	Inst	7				2	5
18-19	A	10					10
18-20	A	5					5
18-22	D	3					3
18-24	A/Inst	10					10
18-29	A	5					5
18-30	A	5					5
18-31	A	5					5
20-2	D	1	1				
20-3	D	3				3	
20-4	D	4				4	
20-6	D	3					3
20-7	D/A	8					8

Insert Arrangement	Service Rating	Total Cont-acts	Contact Size				
			0	4	8	12	16
20-8	Inst	6			2		4
20-9	D/A	8				1	7
20-11	Inst	13					13
20-12	A	2		1			1
20-14	A	5			2	3	
20-15	A	7				7	
20-16	A	9				2	7
20-17	A	6				5	1
20-18	A	9				3	6
20-19	A	3			3		
20-20	A	4		1		3	
20-21	A	9				1	8
20-22	A	6			3		3
20-23	A	2			2		
20-24	A	4			2		2
20-25	Inst	13					13
20-27	A	14					14
20-29	A	17					17
20-30	Inst	13					13
20-33	A	11					11
20-A48	A	19					
22-1	D	2			2		
22-2	D	3			3		
22-4	A	4			2	2	
22-5	D	6				2	4
22-6	D	3			2		1
22-7	E	1	1				
22-8	E	2				2	
22-9	E	3				3	
22-10	E	4					4
22-11	B	2					2
22-12	D	5			2	3	
22-13	D/A	5				4	1
22-14	A	19					19
22-15	E/A	6				5	1
22-16	A	9				3	6
22-17	D/A	9				1	8
22-18	D/A	8					8
22-19	A	14					14
22-20	A	9					9
22-21	A	3	1				2
22-22	A	4			4		
22-23	D/A	8				8	
22-24	D/A	6				2	4
22-27	D/A	9			1		8
22-28	A	7				7	
22-34	D	5				3	2
24-2	D	7				7	
24-3	D	7				2	5
24-4	D	4	1				3
24-5	A	16					16
24-6	D/A	8				8	
24-06	A	6		4			2
24-7	A	16				2	14
24-9	A	2		2			
24-10	A	7			7		

Insert Arrangement	Service Rating	Total Cont-acts	Contact Size				
			0	4	8	12	16
24-11	A	9			3	6	
24-12	A	5		2		3	
24-16	D/A	7			1	3	3
24-17	D	5				2	3
24-20	D	11				2	9
24-21	D	10			1		9
24-22	D	4			4		
24-27	E	7					7
24-28	Inst	24					24
28-1	D/A	9			3	6	
28-2	D	14				2	12
28-3	E	3			3		
28-4	E/D	9				2	7
28-5	D	5		2		1	2
28-6	D	3		3			
28-7	D	2		2			
28-8	E/D/A	12				2	10
28-9	D	12				6	6
28-09	A	9		4			5
28-10	D/A	7		2	2	3	
28-11	A	22				4	18
28-12	A	26					26
28-13	A	26					26
28-15	A	35					35
28-16	A	20					20
28-17	B/D/A	15					15
28-18	C/D/A/Inst	12					12
28-19	B/D/A	10				4	6
28-20	A	14				10	4
28-21	A	37					37
28-22	D	6		3			3
28-51	D	12					12
32-1	D/A	5	2			3	
32-3	D	9	1	2		2	4
32-4	D/A/D	14				2	12
32-5	D	2	2				
32-6	A	23		2	3	2	16
32-7	INSTA	35				7	28
32-8	A	30				6	24
32B-13	D	13			13		
32-17	D	4		4			
32-22	A	54					54
36-1	D	22				4	18
36-3	D	6	3			3	
36-4	D/A	3	3				
36-5	A	4	4				
36-6	A	6	2	4			
36-7	A	47				7	40
36-8	A	47				1	46
36-9	A	31		1	2	14	14
36-10	A	48					48
36-11	A	48					48
36-12	A	48					48
36-13	E/A	17				2	15
36-14	D	16			5	5	6
36-15	D/A	35					35
36-16	A	47				7	40
36-17	A	47				7	40
36-18	A	31		1	2	14	14
36-20	A	34			2	2	30
36-46	A	27					27
36-52	A	52					52
40-56	A	85					85
40-63	A	61					61

Insert Arrangements

Front face of pin insert or rear of socket insert illustrated

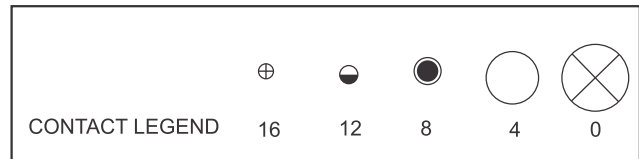

		Front of socket insert	Front of socket insert			
Insert arrangement	10S-2	10SL-3	10SL-4	12S-3	12S-4	12-5
Service rating	A	A	A	A	A	D
Number of contacts	1	3	2	2	1	1
Contact size	16	16	16	16	16	12
Premating contact	-	C	-	-	-	-

Insert arrangement	14S-A7	14S-1	14S-2	14S-4	14S-5	14S-6
Service rating	A	A	Inst.	D	Inst.	Inst.
Number of contacts	7	3	4	1	5	6
Contact size	16	16	16	16	16	16
Premating contact	-	-	-	-	-	-

			100° rotation of 14S-2	100° rotation of 14S-7		
Insert arrangement	14S-7	14S-9	*14S-10	*14S-12	*14-3	16S-1
Service rating	A	A	Inst.	A	A	A
Number of contacts	3	2	4	3	1	7
Contact size	16	16	16	16	8	16
Premating contact	B	-	-	B	-	G

Insert arrangement	*16S-3	16S-4	16S-5	16S-6	16S-8	*16-2
Service rating	B	D	A	A	A	E
Number of contacts	1	2	3	3	5	1
Contact size	16	16	16	16	16	12
Premating contact	-	-	A	B	E	-

*Not tooled up, can be tooled up on request. Contact Factory.

Insert Arrangements

Front face of pin insert or rear of socket insert illustrated

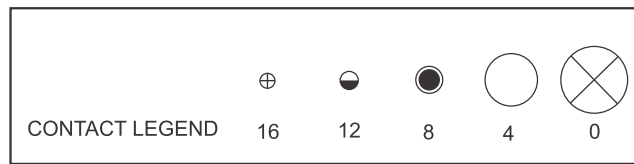

Insert arrangement	16-7	16-9	16-10	16-11	16-12	*16-13
Service rating	A	A	A	A	A	A
Number of contacts	1 2	2 2	3	2	1	2
Contact size	8 16	12 16	12	12	4	12
Premating contact	C	-	B	-	-	-

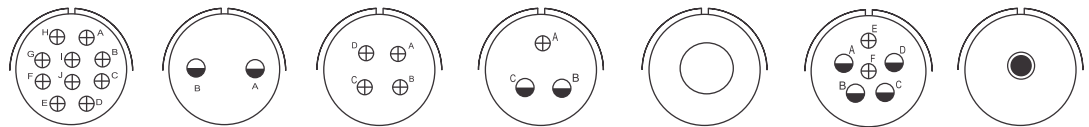

Insert arrangement	18-1	18-3	18-4	18-5	*18-6	18-06	18-7
Service rating	B,C,F,G=A; Bal.=Inst.	D	D	D	D	A	B
Number of contacts	10	2	4	2 1	1	2 4	1
Contact size	16	12	16	12 16	4	16 12	8
Premating contact	-	-	A	C	-	-	-



Insert arrangement	18-8	18-9	18-10	18-11	18-12	*18-13
Service rating	A	Inst.	A	A	A	A
Number of contacts	1 7	2 5	4	5	6	1 3
Contact size	12 16	12 16	12	12	16	8 12
Premating contact	H	-	D	E	C or D	A

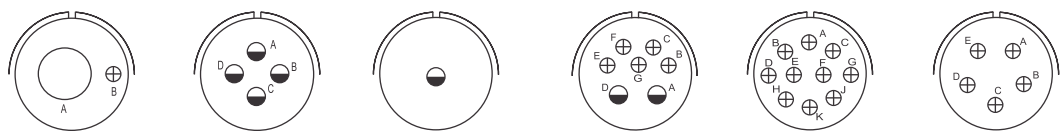

Insert arrangement	*18-14	18-15	18-16	*18-17	18-19	18-20
Service rating	A	A	C	Inst.	A	A
Number of contacts	1 1	4	1	2 5	10	5
Contact size	4 16	12	12	12 16	16	16
Premating contact	-	-	-	-	K	D

100° rotation of 18-9

*Not tooled up, can be tooled up on request. Contact Factory.

Insert Arrangements

Front face of pin insert or rear of socket insert illustrated

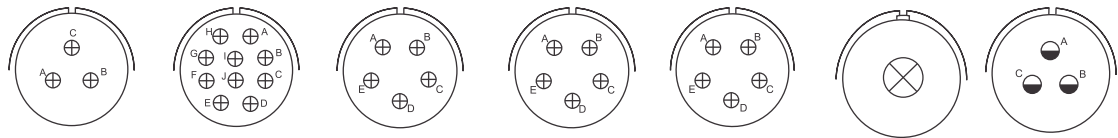

		250° rotation of 18-1		110° rotation of 18-20	260° rotation of 18-20		
Insert arrangement	18-22	*18-24	*18-29	*18-30	*18-31	20-2	20-3
Service rating	D	B,C,F,G=A; Bal.=Inst.	A	A	A	D	D
Number of contacts	3	10	5	5	5	1	4
Contact size	16	16	16	16	16	0	12
Premating contact	C	-	D	C	C	-	A



Insert arrangement	20-4	*20-6	20-7	20-8	20-9	20A-9
Service rating	D	D	A,B,H,G=D; C,D,E,F=A	Inst.	H=D; Bal.=A	A
Number of contacts	4	3	8	2 4	1 7	9
Contact size	12	16	16	8 16	12 16	12
Premating contact	C or D	A	A	-	H	-

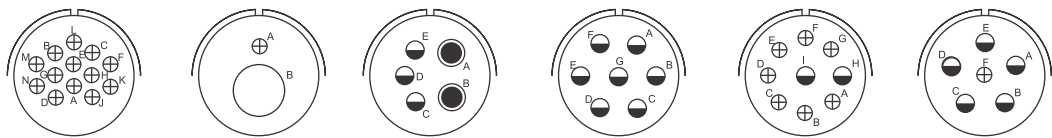

Insert arrangement	20-11	*20-12	20-14	20-15	20-16	20-17
Service rating	Inst.	A	A	A	A	A
Number of contacts	13	1 1	2 3	7	2 7	5 1
Contact size	16	4 16	8 12	12	12 16	12 16
Premating contact	-	-	D	A or D	E	E or F

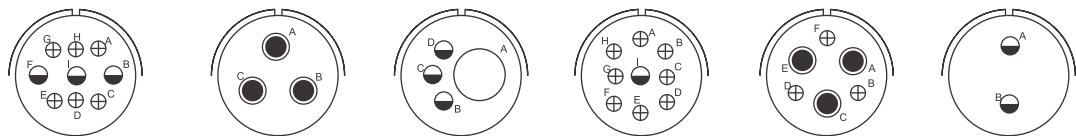

Insert arrangement	20-18	20-19	20-20	*20-21	20-22	20-23
Service rating	A	A	A	A	A	A
Number of contacts	3 6	3	1 3	1 8	3 3	2
Contact size	12 16	8	4 12	12 16	8 16	8
Premating contact	D	C	A	1	-	-

*Not tooled up, can be tooled up on request. Contact Factory.

Insert Arrangements

Front face of pin insert or rear of socket insert illustrated

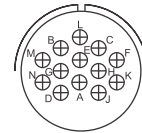
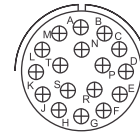
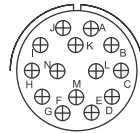
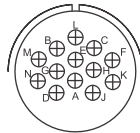
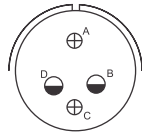
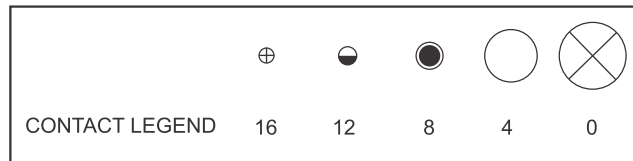

Insert arrangement
Service rating
Number of contacts
Contact size
Premating contact

20-24
A
2 2
8 16
-

100° rotation
of 20-11

*20-25
Inst.
13
16
-

20-27
A
14
16
M

20-29
A
17
16
G

250° rotation
of 20-11

*20-30
Inst.
13
16
-

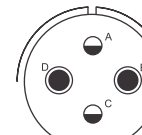
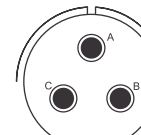
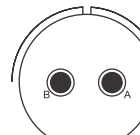
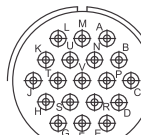
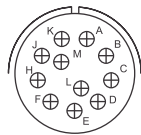

Insert arrangement
Service rating
Number of contacts
Contact size
Premating contact

20-33
A
11
16
E

20 A - 48
A
19
16
-

22-1
D
2
8
-

22-2
D
3
8
A

*22-4
A
2 2
8 12
C

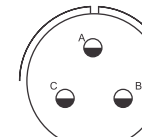
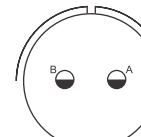
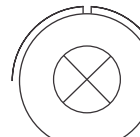
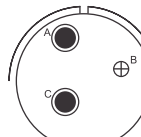
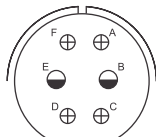

Insert arrangement
Service rating
Number of contacts
Contact size
Premating contact

22-5
D
2 4
12 16
D

*22-6
D
2 1
8 16
B

22-7
E
1
0
-

*22-8
E
2
12
-

22-9
E
3
12
A

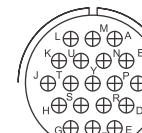
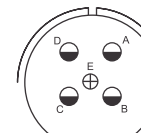
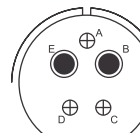
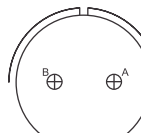
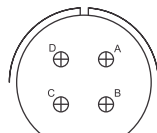

Insert arrangement
Service rating
Number of contacts
Contact size
Premating contact

22-10
E
4
16
C

22-11
B
2
16
-

22-12
D
2 3
8 16
A

22-13
E=D; A, B, C, D=A
4 1
12 16
E

22-14
A
19
16
A

*Not tooled up, can be tooled up on request. Contact Factory.

Insert Arrangements

Front face of pin insert or rear of socket insert illustrated

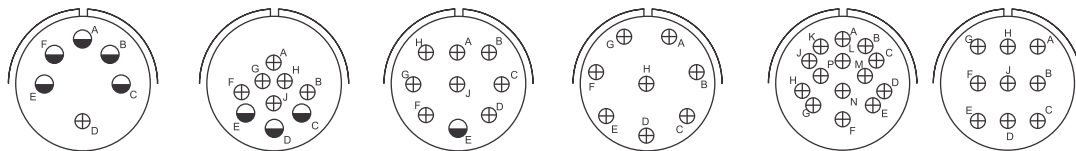

Insert arrangement	22-15	22-16	*22-17	22-18	22-19	22-20
Service rating	D=E;A,B,C,E,F=A	A	A=D;Bal.=A	A,B,F,G,H=D;C,D,E=A	A	A
Number of contacts	5 1	3 6	1 8	8	14	9
Contact size	12 16	12 16	12 16	16	16	16
Premating contact	D	D	E	D	F	D

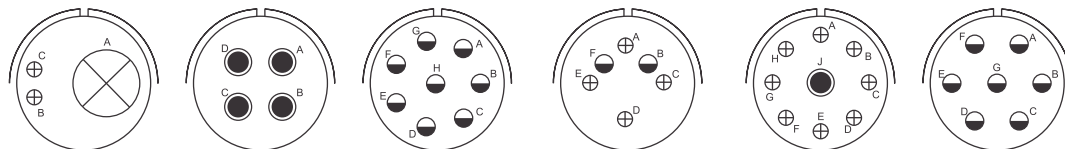

Insert arrangement	*22-21	22-22	22-23	22-24	22-27	22-28
Service rating	A	A	H=D;Bal.=A	C,D,E=D;A,B,F=A	J=D;Bal.=A	A
Number of contacts	1 2	4	8	2 4	1 8	7
Contact size	0 16	8	12 16	12 16	8 16	12
Premating contact	-	C or D	A or D	D	-	G

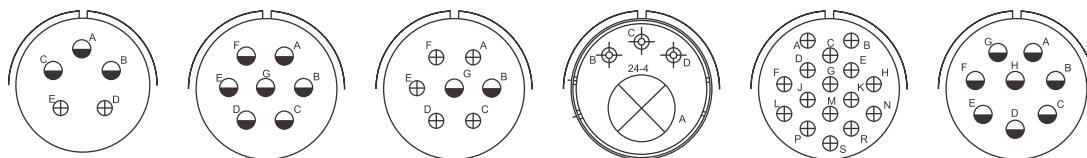

Insert arrangement	*22-34	24-2	*24-3	24-4	24-5	24-6
Service rating	D	D	D	A	A	A,G,H=D;Bal.=A
Number of contacts	3 2	7	2 5	3 1	16	8
Contact size	12 16	12	12 16	16 0	16	12
Premating contact	E	A	D	-	S	D

*Not tooled up, can be tooled up on request. Contact Factory.

Insert Arrangements

Front face of pin insert or rear of socket insert illustrated

CONTACT LEGEND	16	12	8	4	0

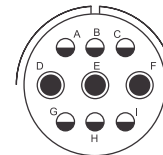
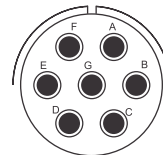
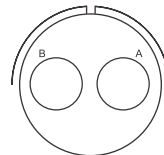
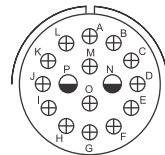
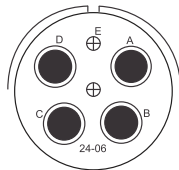

Insert arrangement
Service rating
Number of contacts
Contact size
Premating contact

24-06
A
2 4
16 8
-

24-7
A
2 14
12 16
G

24-9
A
2
4
-

24-10
A
7
8
D or E or G

24-11
A
3 6
8 12
E

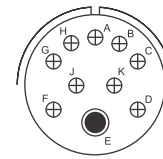
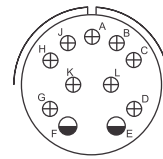
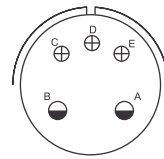
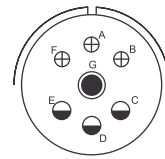
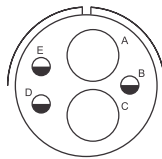

Insert arrangement
Service rating
Number of contacts
Contact size
Premating contact

24-12
A
2 3
4 12
-

*24-16
A,B,F,G=D; C,D,E=A
1 3 3
8 12 16
G

*24-17
D
2 3
12 16
D

24-20
D
2 9
12 16
A

24-21
D
1 9
8 16
E

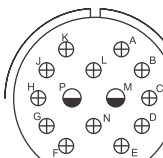
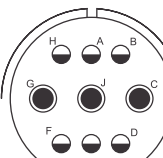
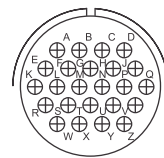
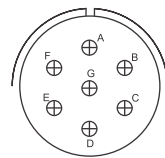
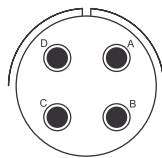

Insert arrangement
Service rating
Number of contacts
Contact size
Premating contact

24-22
D
4
8
D

*24-27
E
7
16
D

24-28
Inst.
24
16
-

28-1
A,J,E=D; Bal.=A
3 6
8 12
E

*28-2
D
2 12
12 16
E

*Not tooled up, can be tooled up on request. Contact Factory.

Insert Arrangements

Front face of pin insert or rear of socket insert illustrated

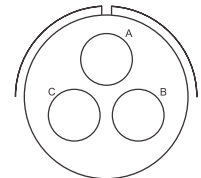
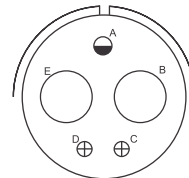
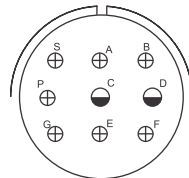
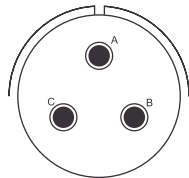
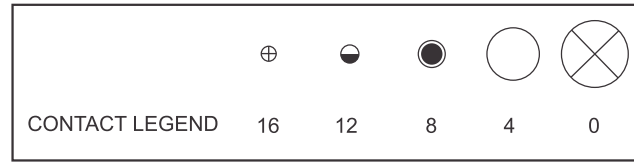

Insert arrangement
Service rating
Number of contacts
Contact size
Premating contact

28-3
E
3
8
A

*28-4
G,S,P=E;Bal.=D
2 7
12 16
E

*28-5
D
2 1 2
4 12 16
-

28-6
D
3
4
A

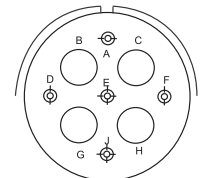
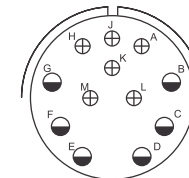
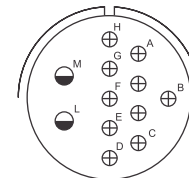
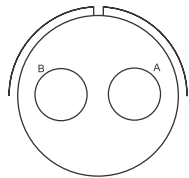

Insert arrangement
Service rating
Number of contacts
Contact size
Premating contact

28-7
D
2
4
-

28-8
L,M=E;B=D;Bal.=A
2 10
12 16
D

28-9
D
6 6
12 16
E

28-09
A
5 4
16 4
-

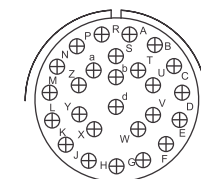
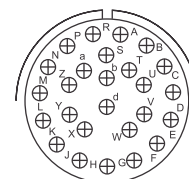
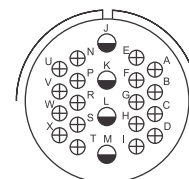
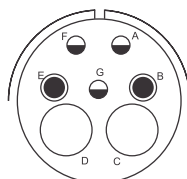

Insert arrangement
Service rating
Number of contacts
Contact size
Premating contact

28-10
G=D;Bal.=A
2 2 3
4 8 12
G

28-11
A
4 18
12 16
M

28-12
A
26
16
H

*28-13
A
26
16
H

*Not tooled up, can be tooled up on request. Contact Factory.

Insert Arrangements

Front face of pin insert or rear of socket insert illustrated

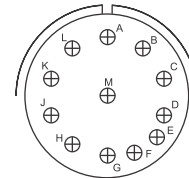
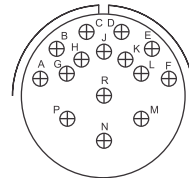
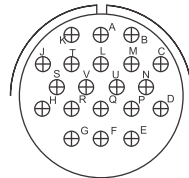
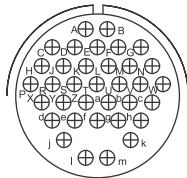
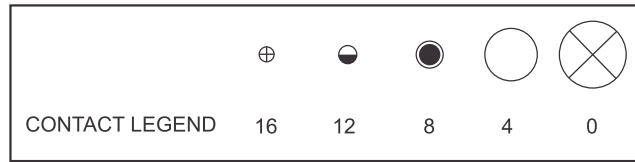

Insert arrangement 28-15
 Service rating A
 Number of contacts 35
 Contact size 16
 Premating contact M

28-16
 A
 20
 16
 F

*28-17
 R=B;M,N,P=D;A to L=A
 15
 16
 N

28-18
 M=C;G,H,J,K,L=D;A,B=ABal.=Inst.
 12
 16
 -

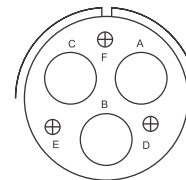
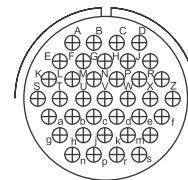
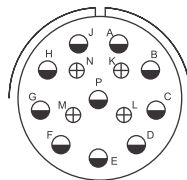
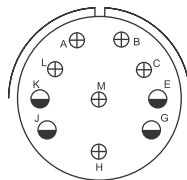

Insert arrangement 28-19
 Service rating H,M=B;A,B=D;Bal.=A
 Number of contacts 4 6
 Contact size 12 16
 Premating contact H

28-20
 A
 10 4
 12 16
 E

28-21
 A
 37
 16
 A

28-22
 D
 3 3
 4 16
 -

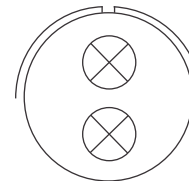
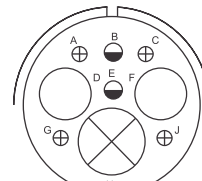
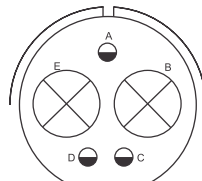
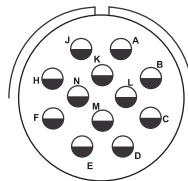

Insert arrangement 28-51
 Service rating D
 Number of contacts 12
 Contact size 12
 Premating contact -

32-1
 A=E;B,C,D,E=A
 2 3
 0 12
 -

*32-3
 D
 1 2 2 4
 0 4 12 16
 -

32-5
 D
 2
 0

*Not tooled up, can be tooled up on request. Contact Factory.

Insert Arrangements

Front face of pin insert or rear of socket insert illustrated

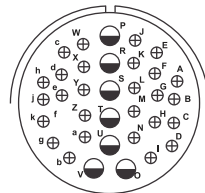
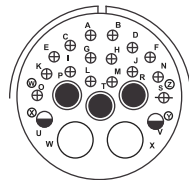
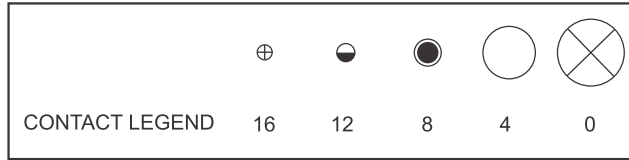

Insert arrangement
Service rating
Number of contacts
Contact size
Premating contact

32-6
A
16 2 3 2
16 12 8 4
-

32-7
INST, A
4 24 7
16 12
-

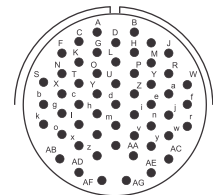
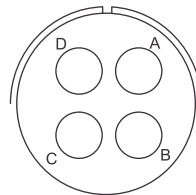
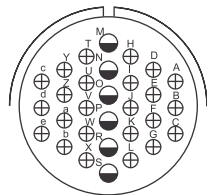

Insert arrangement
Service rating
Number of contacts
Contact size
Premating contact

32-8
A
6 24
12 16
S

32-17
D
4
4
-

32-22
A
54
16
-

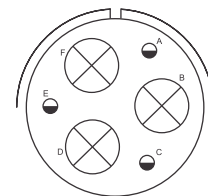
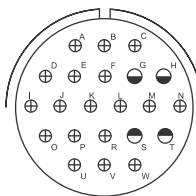
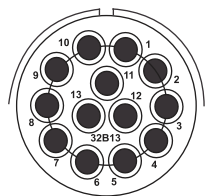

Insert arrangement
Service rating
Number of contacts
Contact size
Premating contact

32B-13
D
13
8
-

*36-1
D
4 18
12 16
-

36-3
D
3 3
0 12
-

*Not tooled up, can be tooled up on request. Contact Factory.

Insert Arrangements

Front face of pin insert or rear of socket insert illustrated

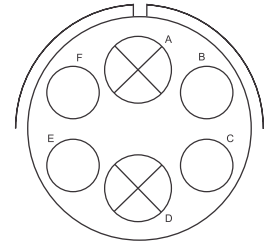
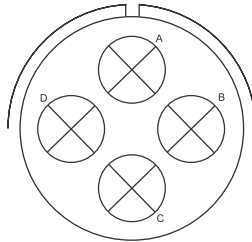
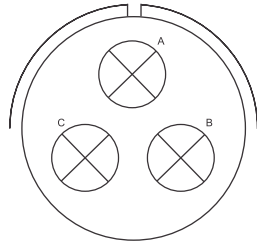
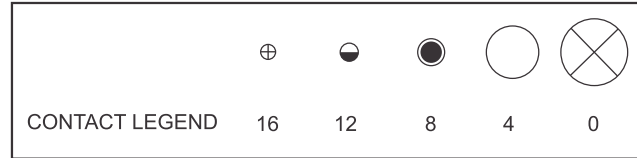

Insert arrangement
Service rating
Number of contacts
Contact size
Premating contact

36-4
A=D; B,C=A
3
0
-

36-5
A
4
0
-

36-6
A
2 4
0 4
-

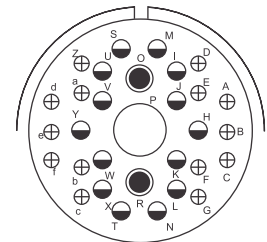
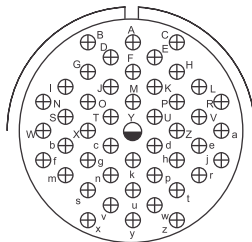
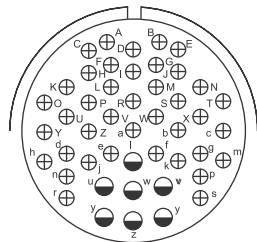

Insert arrangement
Service rating
Number of contacts
Contact size
Premating contact

*36-7
A
7 40
12 16
x or y

*36-8
A
1 46
12 16
Y

*36-9
A
1 2 14 14
4 8 12 16
P

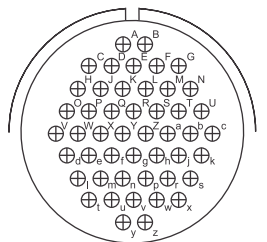
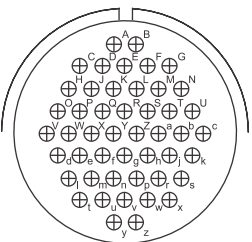
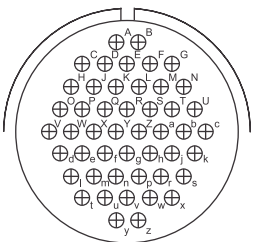

Insert arrangement
Service rating
Number of contacts
Contact size
Premating contact

36-10
A
48
16
A

100°rotation
of 36-10
*36-11
A
48
16
A

250°rotation
of 36-10
*36-12
A
48
16
A

*Not tooled up, can be tooled up on request. Contact Factory.

Insert Arrangements

Front face of pin insert or rear of socket insert illustrated

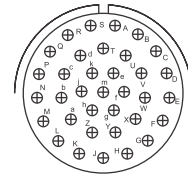
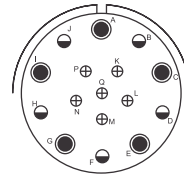
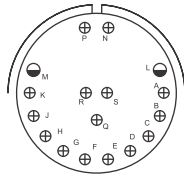
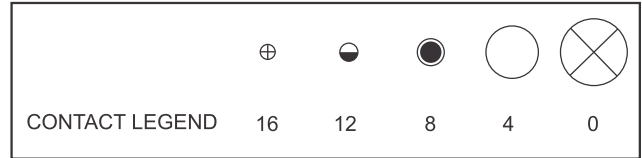

Insert arrangement
Service rating
Number of contacts
Contact size
Premating contact

*36-13
N,P,Q=E;Bal.=A
2 15
12 16
-

*36-14
D
5 5 6
8 12 16
-

*36-15
M=D;Bal=A
35
16
J

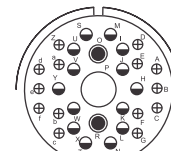
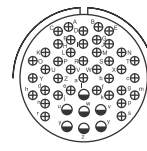
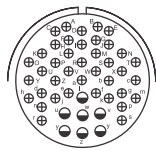

100°rotation
of 36-7

250°rotation
of 36-7

100°rotation
of 36-9

Insert arrangement
Service rating
Number of contacts
Contact size
Premating contact

*36-16
A
7 40
12 16
x or y

*36-17
A
7 40
12 16
x or y

*36-18
A
1 2 14 14
4 8 12 16
-

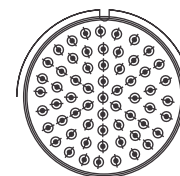
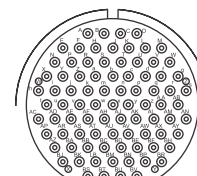
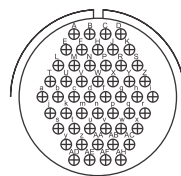
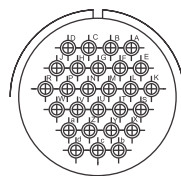
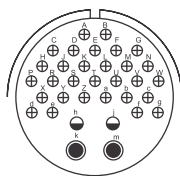

Insert arrangement
Service rating
Number of contacts
Contact size
Premating contact

*36-20
A
2 2 30
8 12 16
k

36-46
A
27
16
-

36-52
A
52
16
-

40-56
A
85
16
-

40-63
A
61
16
-

*Not tooled up, can be tooled up on request. Contact Factory.

Box Mounting Receptacle

102

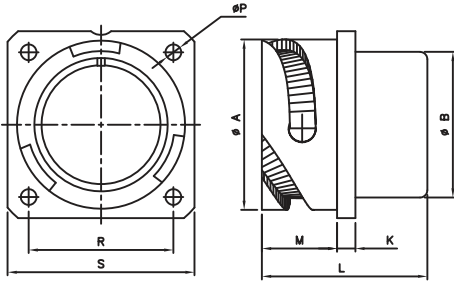

SHELL SIZE	'A' +0.0 -0.15	'B' MAX.	'K' ±0.20	'M' +0.41 -0.0	'R'	'S' ±0.20	'L' ±0.30	'P' ±0.10
10SL	18.21	16.20	2.79	14.20	18.20	25.40	24.70	3.23
12S	21.40	17.80	3.20	14.20	20.60	28.00	24.70	
14S	24.61	19.20	3.20	14.20	23.00	30.00	24.70	
16S	27.41	22.40	3.20	14.20	24.60	32.50	24.70	
16	27.41	22.40	3.20	19.00	24.60	32.50	33.80	
18	30.81	25.60	3.99	19.00	27.00	35.00	33.80	
20	34.19	29.00	3.99	19.00	29.40	38.00	33.80	
22	37.39	32.20	3.99	19.00	31.80	41.00	33.80	
24	40.89	35.30	3.99	20.60	34.90	44.50	35.70	
28	46.71	41.40	3.99	20.60	39.70	50.80	35.70	
32	53.39	47.80	3.99	22.20	44.50	57.00	37.30	
36	59.59	54.10	3.99	22.20	49.20	63.50	37.30	

Rear Mounting Receptacle

103

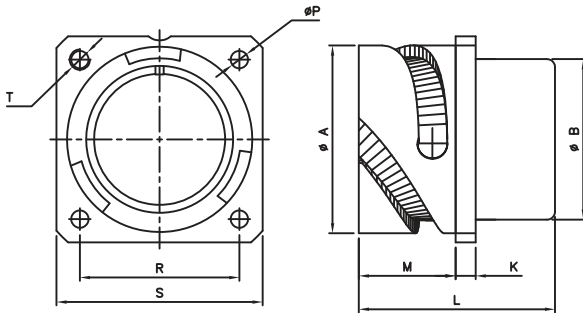

SHELL SIZE	'A' +0.0 -0.15	'B' MAX.	'K' ±0.20	'M' +0.41 -0.0	'R'	'S' ±0.20	'L' ±0.30	'P' ±0.10	'T'
10SL	18.21	16.20	2.79	18.20	18.20	25.40	27.60	3.23	M4
12S	21.40	18.20	3.20	18.20	20.60	28.00	27.60		
14S	24.61	19.20	3.20	18.20	23.00	30.00	27.60		
16S	27.41	22.40	3.20	18.20	24.60	32.50	27.60		
16	27.41	22.40	3.20	23.05	24.60	32.50	33.80		
18	30.81	25.60	3.99	23.05	27.00	35.00	33.80		
20	34.19	29.00	3.99	23.05	29.40	38.00	33.80		
22	37.39	32.20	3.99	23.05	31.80	41.00	33.80		
24	40.89	35.30	3.99	23.05	34.90	44.50	35.70		
28	46.71	41.40	3.99	24.05	39.70	50.80	35.70		
32	53.39	47.80	3.99	24.05	44.50	57.00	37.30		
36	59.59	54.10	3.99	24.05	49.20	63.50	37.30		

Jam Nut Receptacle

107

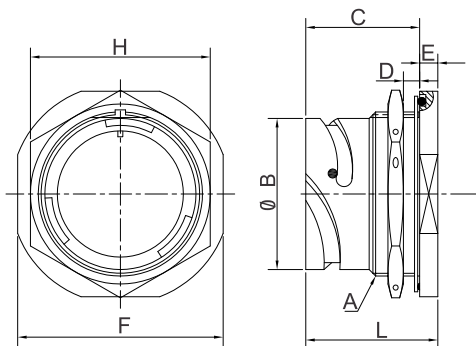

SHELL SIZE	A -2A THREADS	B +0.0 -0.15	C	D WALL THICKNESS		E	F +0.25	H	L
				MIN	MAX				
10SL	7/8" - 20 UNEF	18.20	24.50	2.40	5.20	4.00	31.80	27.00	27.70
14S	1" 1/8-18 UNEF	24.60	26.80	2.40	7.50	4.80	41.30	33.00	30.00
16S	1" 1/4-18 UNEF	27.40	26.80	2.40	7.50	4.80	44.40	38.10	30.00
16	1" 1/4- 18 UNEF	27.40	32.10	2.40	7.50	4.80	44.40	38.10	35.30
18	1" 3/8- 18 UNEF	30.80	33.70	2.40	9.00	4.80	47.60	39.70	37.70
20	1" 1/2- 18 UNEF	34.20	33.70	2.40	9.00	4.80	50.80	44.00	37.70
22	1" 5/8- 18 UNEF	37.40	33.70	2.40	9.10	4.80	54.20	46.00	37.70
24	1" 3/4- 18 UNS	40.90	33.70	2.40	9.10	4.80	57.20	50.80	37.70
28	2" - 18 UNS	46.70	35.20	2.40	8.50	5.60	63.50	55.00	39.20
32	2" 1/4- 16 UN	53.40	35.20	2.40	6.50	5.60	69.80	62.00	39.20
36	2" 1/2- 16 UN	59.60	35.20	2.40	8.30	5.60	76.20	71.00	39.20

Box Mount Receptacle With PC Tail Contacts

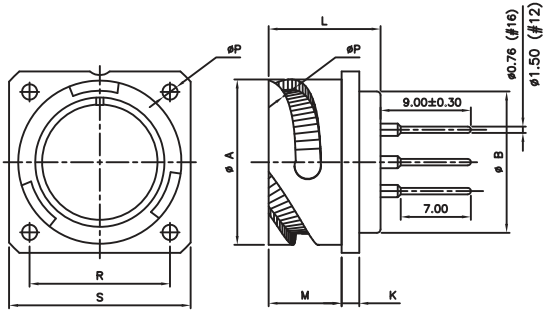

SHELL SIZE	'A' +0.0 -0.15	'B' MAX.	'K' ±0.20	'M' +0.41 -0.0	'R'	'S' ±0.20	'L' ±0.30	'P' ±0.10
10SL	18.21	16.20	2.79	14.20	18.20	25.40	24.70	3.23
12S	21.40	17.80	3.20	14.20	20.60	28.00	24.70	
14S	24.61	19.20	3.20	14.20	23.00	30.00	24.70	
16S	27.41	22.40	3.20	14.20	24.60	32.50	24.70	
16	27.41	22.40	3.20	19.00	24.60	32.50	33.80	
18	30.81	25.60	3.99	19.00	27.00	35.00	33.80	
20	34.19	29.00	3.99	19.00	29.40	38.00	33.80	
22	37.39	32.20	3.99	19.00	31.80	41.00	33.80	
24	40.89	35.30	3.99	20.60	34.90	44.50	35.70	
28	46.71	41.40	3.99	20.60	39.70	50.80	35.70	
32	53.39	47.80	3.99	22.20	44.50	57.00	37.30	
36	59.59	54.10	3.99	22.20	49.20	63.50	37.30	

Rear Mount Receptacle With PC Tail Contacts

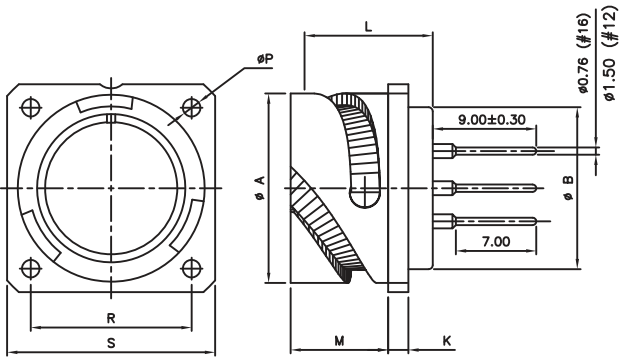

SHELL SIZE	'A' +0.0 -0.15	'B' MAX.	'K' ±0.20	'M' +0.41 -0.0	'R' ±0.10	'S' ±0.20	'L' ±0.30	'P' ±0.10
10SL	18.21	16.20	2.79	18.20	18.20	25.40	27.60	3.23
12S	21.40	18.20	3.20	18.20	20.60	28.00	27.60	
14S	24.61	19.20	3.20	18.20	23.00	30.00	27.60	
16S	27.41	22.40	3.20	18.20	24.60	32.50	27.60	
16	27.41	22.40	3.20	23.05	24.60	32.50	33.80	
18	30.81	25.60	3.99	23.05	27.00	35.00	33.80	
20	34.19	29.00	3.99	23.05	29.40	38.00	33.80	
22	37.39	32.20	3.99	23.05	31.80	41.00	33.80	
24	40.89	35.30	3.99	23.05	34.90	44.50	35.70	
28	46.71	41.40	3.99	24.05	39.70	50.80	35.70	
32	53.39	47.80	3.99	24.05	44.50	57.00	37.30	
36	59.59	54.10	3.99	24.05	49.20	63.50	37.30	

Jam Nut Receptacles With PC Tail Contacts

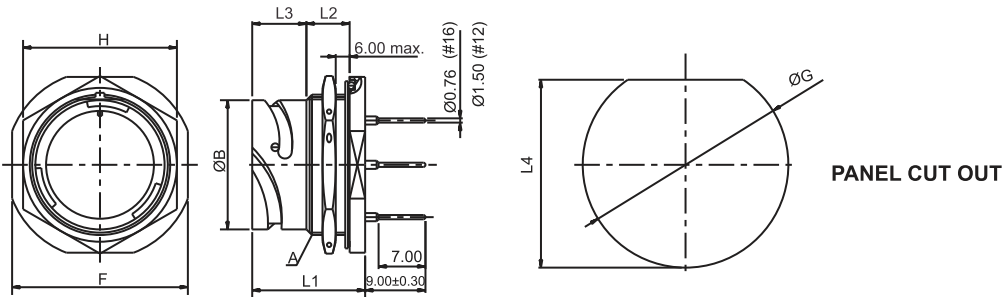

SHELL SIZE	A -2A THREADS	B +0.0 -0.15	F	G	H	L1	L2	L3	L4
10SL	7/8"-20UNEF	18.20	31.80	22.70	27.00	29.20	13.50	12.50	20.90
14S	1" 1/8-18UNEF	24.60	41.30	28.80	33.00	29.20	13.50	12.50	27.20
16S	1" 1/4-18UNEF	27.40	44.40	32.00	38.10	29.20	13.50	12.50	30.40
16	1" 1/4-18UNEF	27.40	44.40	32.00	38.10	37.70	13.50	21.00	30.40
18	1" 3/8-18UNEF	30.80	47.60	35.10	39.70	40.00	15.00	21.00	33.60
20	1" 1/2-18UNEF	34.20	50.80	38.10	44.50	40.00	15.00	21.00	36.80
22	1" 5/8-18UNEF	37.40	54.20	42.00	50.80	40.00	15.00	21.00	39.90
24	1" 3/4-18UNS	40.90	57.20	44.70	50.80	40.00	15.00	21.00	43.10
28	2" -18UNS	46.70	63.50	51.10	55.00	40.00	15.00	21.00	49.20
32	2" 1/4-16 UN	53.40	69.80	57.40	62.00	40.00	15.00	21.00	55.70
36	2" 1/2-16 UN	59.60	76.20	63.80	71.50	40.00	15.00	21.00	62.00
40	2" 3/4-16 UN	65.50	82.20	70.20	76.20	40.00	15.00	21.00	68.50

Wall Mount Receptacle With A Type Solid B/S

100A

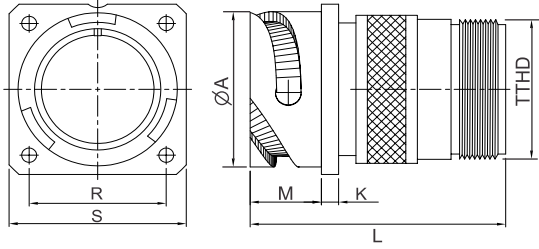

Shell Size	'A' +0.0 -0.15	'K' ±0.20	'M' +0.41 - 0.0	'R'	'S' ±0.20	'L' MAX	'T' THD
10SL	18.21	2.79	14.20	18.20	25.40	45.00	5/8-24 UNEF
12s	21.40	3.20	14.20	20.60	28.00	45.00	5/8-24 UNEF
14s	24.61	3.20	14.20	23.00	30.00	48.00	3/4-20 UNEF
16s	27.41	3.20	14.20	24.60	32.50	48.00	7/8-20 UNEF
6	27.41	3.20	19.00	24.60	32.50	55.00	7/8-20 UNEF
18	30.81	3.99	19.00	27.00	35.00	60.00	1-20 UNEF
20	34.19	3.99	19.00	29.40	38.00	65.00	1 3/16-18UNEF
22	37.39	3.99	19.00	31.80	41.00	65.00	1 3/16-18UNEF
24	40.89	3.99	20.60	34.90	44.50	68.00	1 7/16-18UNEF
28	46.71	3.99	20.60	39.70	50.80	68.00	1 7/16-18UNEF
32	53.39	3.99	22.20	44.50	57.00	70.00	1 3/4-18UNS
36	59.59	3.99	22.20	49.20	63.50	70.00	2-18 UNS

Wall Mount Receptacle With A Type Solid B/S & Environmental Sealing Grommet

100AG

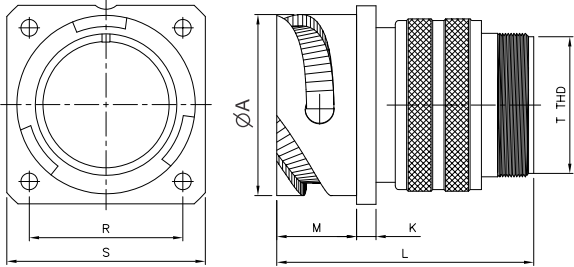

Shell Size	'A' +0.0 -0.15	'K' ±0.20	'M' +0.41 - 0.0	'R'	'S' ±0.20	'L' MAX	'T' THD
10SL	18.21	2.79	14.20	18.20	25.40	68.60	5/8-24 UNEF
12S	21.40	3.20	14.20	20.60	28.00	68.60	5/8-24 UNEF
14S	24.61	3.20	14.20	23.00	30.00	68.60	3/4-20 UNEF
16S	27.41	3.20	14.20	24.60	32.50	68.60	7/8-20 UNEF
6	27.41	3.20	19.00	24.60	32.50	75.00	7/8-20 UNEF
18	30.81	3.99	19.00	27.00	35.00	75.00	1-20 UNEF
20	34.19	3.99	19.00	29.40	38.00	75.00	1 3/16-18UNEF
22	37.39	3.99	19.00	31.80	41.00	75.00	1 3/16-18UNEF
24	40.89	3.99	20.60	34.90	44.50	77.00	1 7/16-18UNEF
28	46.71	3.99	20.60	39.70	50.80	77.00	1 7/16-18UNEF
32	53.39	3.99	22.20	44.50	57.00	80.00	1 3/4-18UNS
36	59.59	3.99	22.20	49.20	63.50	80.00	2-18 UNS

Wall Mount Receptacle With FvType Strain Relief B/S & Environmental Sealing Grommet

100F

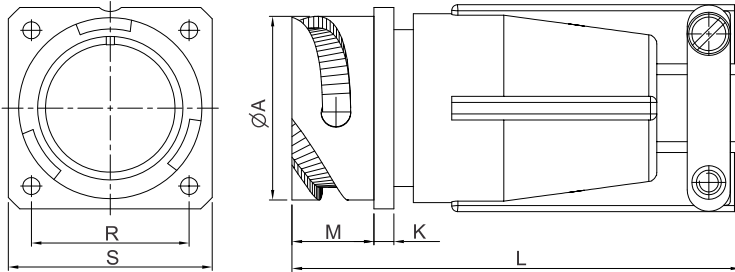

SHELL SIZE	'A' +0.0 -0.15	'K' +0.20	'M' +0.41 -0.0	'R'	'S' +0.20	'L' MAX.
10SL	18.21	2.79	14.20	18.20	25.40	60.00
12S	21.40	3.20	14.20	20.60	28.00	60.00
14S	24.61	3.20	14.20	23.00	30.00	61.00
16S	27.41	3.20	14.20	24.60	32.50	61.00
16	27.41	3.20	19.00	24.60	32.50	68.00
18	30.81	3.99	19.00	27.00	35.00	72.00
20	34.19	3.99	19.00	29.40	38.00	74.00
22	37.39	3.99	19.00	31.80	41.00	74.00
24	40.89	3.99	20.60	34.90	44.50	78.00
28	46.71	3.99	20.60	39.70	50.80	78.00
32	53.39	3.99	22.20	44.50	57.00	82.00
36	59.59	3.99	22.20	49.20	63.50	82.00

Wall Mount Receptacle With R type B/S & Environmental Sealing Grommet

100R

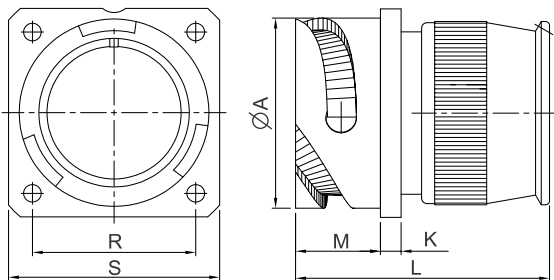

SHELL SIZE	'A' +0.0 -0.15	'K' +0.20	'M' +0.41 -0.0	'R'	'S' +0.20	'L' MAX.
10SL	18.21	2.79	14.20	18.20	25.40	47.00
12S	21.40	3.20	14.20	20.60	28.00	47.00
14S	24.61	3.20	14.20	23.00	30.00	47.00
16S	27.41	3.20	14.20	24.60	32.50	48.00
16	27.41	3.20	19.00	24.60	32.50	54.40
18	30.81	3.99	19.00	27.00	35.00	56.40
20	34.19	3.99	19.00	29.40	38.00	56.40
22	37.39	3.99	19.00	31.80	41.00	56.40
24	40.89	3.99	20.60	34.90	44.50	57.40
28	46.71	3.99	20.60	39.70	50.80	57.40
32	53.39	3.99	22.20	44.50	57.00	58.10
36	59.59	3.99	22.20	49.20	63.50	58.10

Wall Mount Receptacle With G Type B/S For Heat Shrinkable & Environmental Sealing Grommet

100G

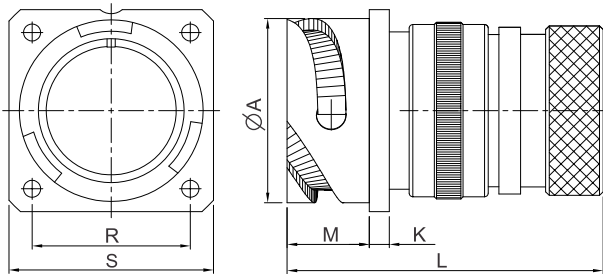

SHELL SIZE	'A' +0.0 -0.15	'K' +0.20	'M' +0.41 -0.0	'R'	'S' +0.20	'L' MAX.
10SL	18.21	2.79	14.20	18.20	25.40	52.50
12S	21.40	3.20	14.20	20.60	28.00	52.50
14S	24.61	3.20	14.20	23.00	30.00	54.40
16S	27.41	3.20	14.20	24.60	32.50	54.40
16	27.41	3.20	19.00	24.60	32.50	61.00
18	30.81	3.99	19.00	27.00	35.00	62.00
20	34.19	3.99	19.00	29.40	38.00	62.00
22	37.39	3.99	19.00	31.80	41.00	65.00
24	40.89	3.99	20.60	34.90	44.50	65.00
28	46.71	3.99	20.60	39.70	50.80	66.00
32	53.39	3.99	22.20	44.50	57.00	71.00
36	59.59	3.99	22.20	49.20	63.50	75.00

Wall Mount Receptacle With PG Threaded Type B/S Suitable For PG Glands

100PG

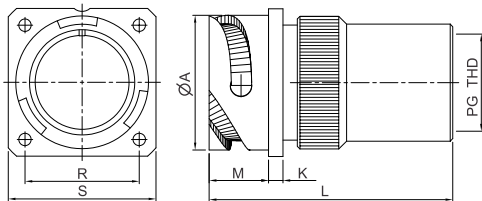

Shell Size	'A' +0.0-0.15	'K' ±0.20	'M' +0.41 - 0.0	'R'	'S' ±0.20	'L' MAX	PG THD
10SL	18.21	2.79	14.20	18.20	25.40	56.00	7, 9, 11
12s	21.40	3.20	14.20	20.60	28.00	56.00	7, 9, 11
14s	24.61	3.20	14.20	23.00	30.00	56.00	11, 13.5
16s	27.41	3.20	14.20	24.60	32.50	58.00	9, 11, 16
6	27.41	3.20	19.00	24.60	32.50	66.00	9, 11, 16
18	30.81	3.99	19.00	27.00	35.00	74.00	9, 11, 16, 21
20	34.19	3.99	19.00	29.40	38.00	74.00	11, 16, 21
22	37.39	3.99	19.00	31.80	41.00	77.00	13.5, 16, 21
24	40.89	3.99	20.60	34.90	44.50	77.00	13.5, 16, 21, 29
28	46.71	3.99	20.60	39.70	50.80	78.00	16, 21, 29
32	53.39	3.99	22.20	44.50	57.00	78.00	21, 29
36	59.59	3.99	22.20	49.20	63.50	90.00	21, 29, 36

Wall Mount Receptacle With EGM B/S For Shielded Cable & PHM B/S Unshielded Cable With Sealing Rubber Bush

100EGM/PHM

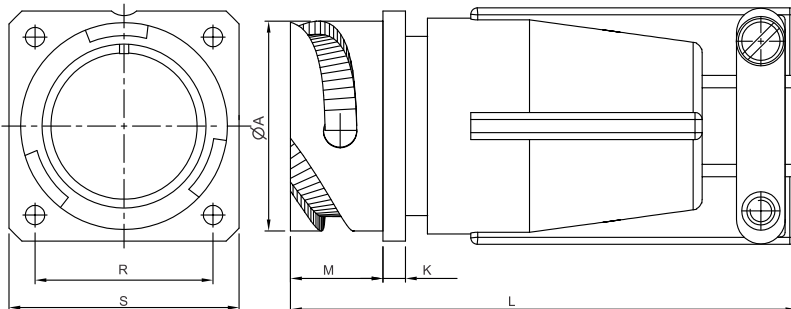

SHELL SIZE	'A' +0.0 -0.15	'K' +0.20	'M' +0.41 -0.0	'R'	'S' +0.20	'L' MAX.
10SL	18.21	2.79	14.20	18.20	25.40	95.60
12S	21.40	3.20	14.20	20.60	28.00	95.60
14S	24.61	3.20	14.20	23.00	30.00	95.60
16S	27.41	3.20	14.20	24.60	32.50	95.60
16	27.41	3.20	19.00	24.60	32.50	102.00
18	30.81	3.99	19.00	27.00	35.00	102.00
20	34.19	3.99	19.00	29.40	38.00	102.00
22	37.39	3.99	19.00	31.80	41.00	102.00
24	40.89	3.99	20.60	34.90	44.50	104.00
28	46.71	3.99	20.60	39.70	50.80	104.00
32	53.39	3.99	22.20	44.50	57.00	106.00
36	59.59	3.99	22.20	49.20	63.50	106.00

Wall Mount Receptacle With SQ type Shielded B/S & Environmental Sealing Grommet & Heat Shrinkable Option

100SQ

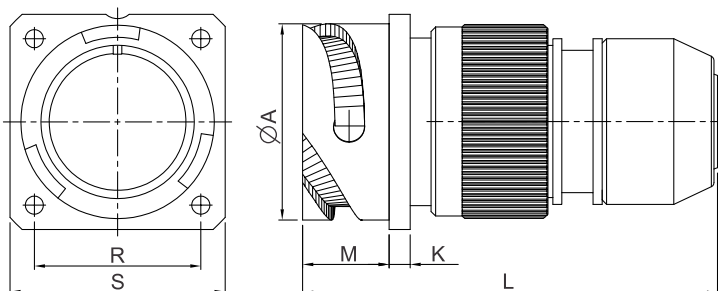

SHELL SIZE	'A' +0.0 -0.15	'K' +0.20	'M' +0.41 -0.0	'R'	'S' +0.20	'L' MAX.
10SL	18.21	2.79	14.20	18.20	25.40	57.00
12S	21.40	3.20	14.20	20.60	28.00	57.00
14S	24.61	3.20	14.20	23.00	30.00	59.00
16S	27.41	3.20	14.20	24.60	32.50	59.00
16	27.41	3.20	19.00	24.60	32.50	66.00
18	30.81	3.99	19.00	27.00	35.00	66.00
20	34.19	3.99	19.00	29.40	38.00	66.00
22	37.39	3.99	19.00	31.80	41.00	66.00
24	40.89	3.99	20.60	34.90	44.50	68.00
28	46.71	3.99	20.60	39.70	50.80	68.00
32	53.39	3.99	22.20	44.50	57.00	70.00
36	59.59	3.99	22.20	49.20	63.50	70.00

Wall Mount Receptacle With Metric Threaded Type B/S Suitable For Metric Glands

100M

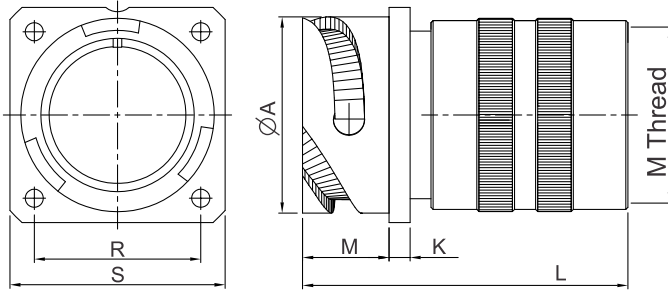

Shell Size	'A' +0.0 -0.15	'K' +0.20	'M' +0.41 - 0.0	'R'	'S' ±0.20	'L' MAX.	M THD
10SL	18.21	2.79	14.20	18.20	25.40	56.00	M12X1.5
14s	24.61	3.20	14.20	23.00	30.00	56.00	M16X1.5
16s	27.41	3.20	14.20	24.60	32.50	58.00	M16X1.5
6	27.41	3.20	19.00	24.60	32.50	66.00	M16X1.5
18	30.81	3.99	19.00	27.00	35.00	74.00	M20X1.5
20	34.19	3.99	19.00	29.40	38.00	74.00	M25X1.5
22	37.39	3.99	19.00	31.80	41.00	77.00	M25X1.5
24	40.89	3.99	20.60	34.90	44.50	77.00	M32X1.5
28	46.71	3.99	20.60	39.70	50.80	78.00	M32X1.5
32	53.39	3.99	22.20	44.50	57.00	78.00	M36X1.5
36	59.59	3.99	22.20	49.20	63.50	90.00	M40X1.5

Wall Mount Receptacle With 90° B/S & Environmental Sealing Grommet

100RT

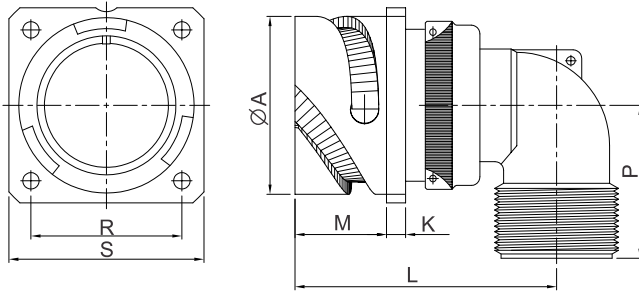

SHELL SIZE	'A' +0.0 -0.15	'K' +0.20	'M' +0.41 -0.0	'R'	'S' +0.20	'L' MAX.	'P' MAX.
10SL	18.21	2.79	14.20	18.20	25.40	40.50	21.50
12S	21.40	3.20	14.20	20.60	28.00	40.50	21.50
14S	24.61	3.20	14.20	23.00	30.00	42.00	23.00
16S	27.41	3.20	14.20	24.60	32.50	45.00	24.60
16	27.41	3.20	19.00	24.60	32.50	52.00	24.60
18	30.81	3.99	19.00	27.00	35.00	53.00	27.00
20	34.19	3.99	19.00	29.40	38.00	58.00	29.00
22	37.39	3.99	19.00	31.80	41.00	58.00	31.00
24	40.89	3.99	20.60	34.90	44.50	63.00	34.00
28	46.71	3.99	20.60	39.70	50.80	63.00	36.00
32	53.39	3.99	22.20	44.50	57.00	69.00	44.00
36	59.59	3.99	22.20	49.20	63.50	72.30	46.00

Cable Connecting Receptacle With A type Solid B/S

101A

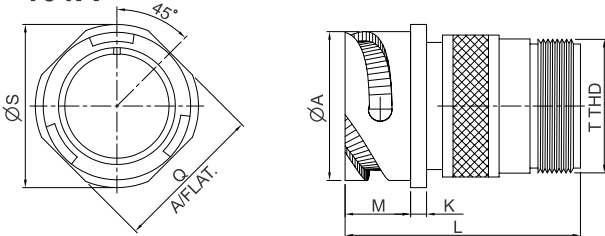

Shell Size	'A' +0.0 -0.15	'K' ±0.20	'M' +0.41 - 0.0	'Q'	'S' ±0.20	'L' MAX	'T' THD
10SL	18.21	2.79	14.20	20.60	25.00	45.00	5/8-24 UNEF
12s	21.40	3.20	14.20	23.60	27.60	45.00	5/8-24 UNEF
14s	24.61	3.20	14.20	25.40	29.60	48.00	3/4-20 UNEF
16s	27.41	3.20	14.20	28.60	32.10	48.00	7/8-20 UNEF
6	27.41	3.20	19.00	28.60	32.10	55.00	7/8-20 UNEF
18	30.81	3.99	19.00	31.70	34.60	60.00	1-20 UNEF
20	34.19	3.99	19.00	34.90	37.60	65.00	1 3/16-18UNEF
22	37.39	3.99	19.00	31.80	40.90	65.00	1 3/16-18UNEF
24	40.89	3.99	20.60	41.30	44.40	68.00	1 7/16-18UNEF
28	46.71	3.99	20.60	47.60	50.70	68.00	1 7/16-18UNEF
32	53.39	3.99	22.20	54.0	56.90	70.00	1 3/4-18UNS
36	59.59	3.99	22.20	60.60	63.40	70.00	2-18 UNS

Cable Connecting Receptacle With F type Strain Relief B/S & Environmental Sealing Grommet

101F

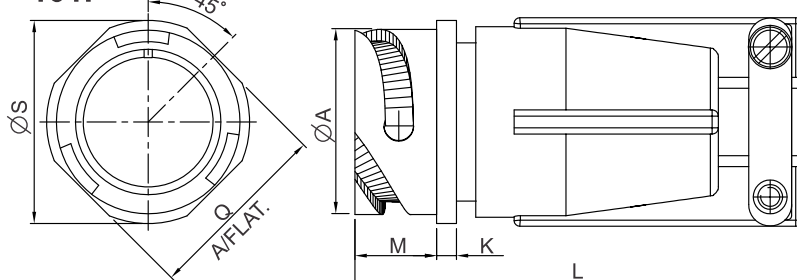

SHELL SIZE	'A' +0.0 -0.15	'K' +0.20	'M' +0.41 -0.0	'Q'	'S' +0.20	'L' MAX.
10SL	18.21	2.79	14.20	20.60	25.0	60.00
12S	21.40	3.20	14.20	23.60	27.60	60.00
14S	24.61	3.20	14.20	25.40	29.60	61.00
16S	27.41	3.20	14.20	28.60	32.10	61.00
16	27.41	3.20	19.00	28.60	32.10	68.00
18	30.81	3.99	19.00	31.70	34.60	72.00
20	34.19	3.99	19.00	34.90	37.60	74.00
22	37.39	3.99	19.00	31.80	40.90	74.00
24	40.89	3.99	20.60	41.30	44.40	78.00
28	46.71	3.99	20.60	47.60	50.70	78.00
32	53.39	3.99	22.20	54.0	56.90	82.00
36	59.59	3.99	22.20	60.60	63.40	82.00

Cable Connecting Receptacle With R Type B/S & Environmental Sealing Grommet

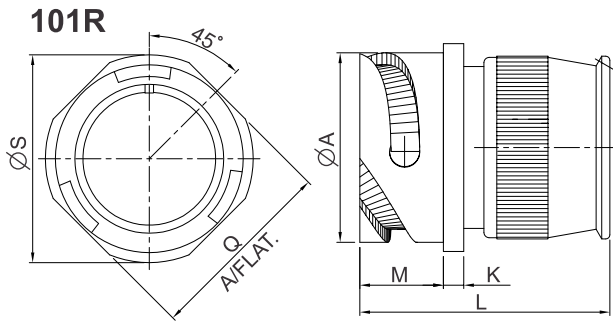

SHELL SIZE	'A' +0.0 -0.15	'K' +0.20	'M' +0.41 -0.0	'Q' +0.20	'S' +0.20	'L' MAX.
10SL	18.21	2.79	14.20	20.60	25.00	47.00
12S	21.40	3.20	14.20	23.60	27.60	47.00
14S	24.61	3.20	14.20	25.40	29.60	47.00
16S	27.41	3.20	14.20	28.60	32.10	48.00
16	27.41	3.20	19.00	28.60	32.10	54.40
18	30.81	3.99	19.00	31.70	34.60	56.40
20	34.19	3.99	19.00	34.90	37.60	56.40
22	37.39	3.99	19.00	31.80	40.90	56.40
24	40.89	3.99	20.60	41.30	44.40	57.40
28	46.71	3.99	20.60	47.60	50.70	57.40
32	53.39	3.99	22.20	54.00	56.90	58.10
36	59.59	3.99	22.20	60.00	63.40	58.10

Cable Connecting Receptacle With G Type B/S For Heat Shrinkable & Environmental Sealing Grommet

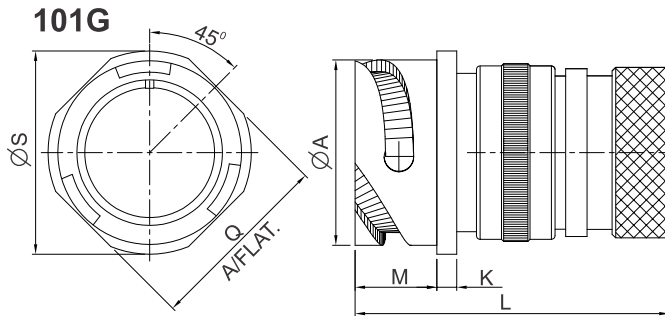

SHELL SIZE	'A' +0.0 -0.15	'K' +0.20	'M' +0.41 -0.0	'Q' +0.20	'S' +0.20	'L' MAX.
10SL	18.21	2.79	14.20	20.60	25.40	52.50
12S	21.40	3.20	14.20	23.60	28.00	52.50
14S	24.61	3.20	14.20	25.40	30.00	54.40
16S	27.41	3.20	14.20	28.60	32.50	54.40
16	27.41	3.20	19.00	28.60	32.50	61.00
18	30.81	3.99	19.00	31.70	35.00	62.00
20	34.19	3.99	19.00	34.90	38.00	63.00
22	37.39	3.99	19.00	31.80	41.00	65.00
24	40.89	3.99	20.60	41.30	44.50	65.00
28	46.71	3.99	20.60	47.60	50.80	66.00
32	53.39	3.99	22.20	54.0	57.00	71.00
36	59.59	3.99	22.20	60.60	63.50	75.00

Cable Connecting Receptacle With A Type Solid B/S & Environmental Sealing Grommet

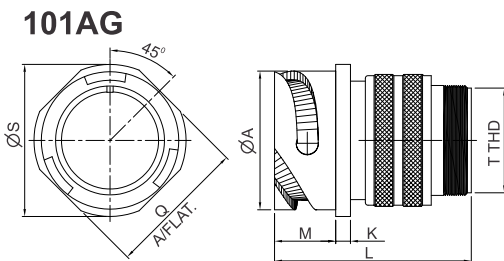

Shell Size	'A' +0.0 -0.15	'K' ±0.20	'M' +0.41 - 0.0	'Q' +0.20	'S' ±0.20	'L' MAX	'T' THD
10SL	18.21	2.79	14.20	20.60	25.40	68.60	5/8-24 UNEF
12s	21.40	3.20	14.20	23.60	28.00	68.60	5/8-24 UNEF
14s	24.61	3.20	14.20	25.40	30.00	68.60	3/4-20 UNEF
16s	27.41	3.20	14.20	28.60	32.50	68.60	7/8-20 UNEF
6	27.41	3.20	19.00	28.60	32.50	75.00	7/8-20 UNEF
18	30.81	3.99	19.00	31.70	35.00	75.00	1-20 UNEF
20	34.19	3.99	19.00	34.90	38.00	75.00	1 3/16-18UNEF
22	37.39	3.99	19.00	31.80	41.00	75.00	1 3/16-18UNEF
24	40.89	3.99	20.60	41.30	44.50	77.00	1 7/16-18UNEF
28	46.71	3.99	20.60	47.60	50.80	77.00	1 7/16-18UNEF
32	53.39	3.99	22.20	54.0	57.00	80.00	1 3/4-18UNS
36	59.59	3.99	22.20	60.60	63.50	80.00	2-18 UNS

Cable Connecting Receptacle With PG Threaded Type B/S Suitable For PG Glands

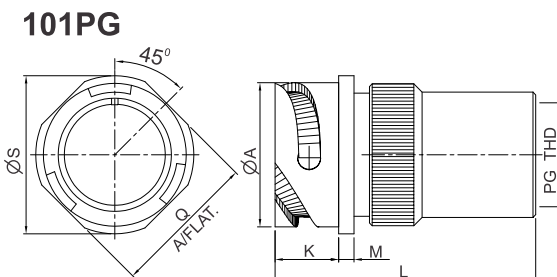

Shell Size	'A' +0.0 -0.15	'K' ±0.20	'M' +0.41 - 0.0	'Q' +0.20	'S' ±0.20	'L' MAX	PG THD
10SL	18.21	2.79	14.20	20.60	25.40	56.00	7, 9, 11
12s	21.40	3.20	14.20	23.60	28.00	56.00	7, 9, 11
14s	24.61	3.20	14.20	25.40	30.00	56.00	11, 13.5
16s	27.41	3.20	14.20	28.60	32.50	58.00	9, 11, 16
6	27.41	3.20	19.00	28.60	32.50	66.00	9, 11, 16
18	30.81	3.99	19.00	31.70	35.00	74.00	9, 11, 16, 21
20	34.19	3.99	19.00	34.90	38.00	74.00	11, 16, 21
22	37.39	3.99	19.00	31.80	41.00	77.00	13.5, 16, 21
24	40.89	3.99	20.60	41.30	44.50	77.00	13.5, 16, 21, 29
28	46.71	3.99	20.60	47.60	50.80	78.00	16, 21, 29
32	53.39	3.99	22.20	54.0	57.00	78.00	21, 29
36	59.59	3.99	22.20	60.60	63.50	90.00	21, 29, 36

Cable Connecting Receptacle With EGM B/S For Shielded Cable & PHM B/S Unshielded Cable With Sealing Rubber Bush

101EGM/PHM

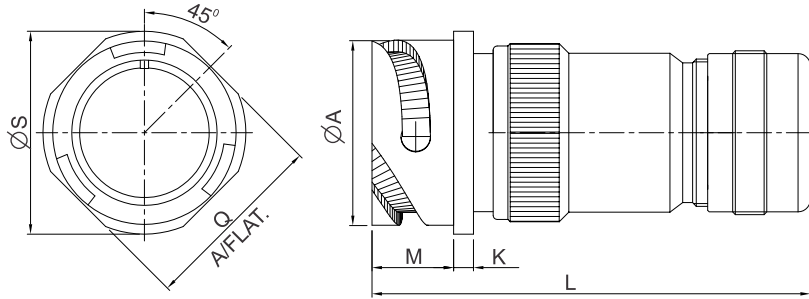

SHELL SIZE	'A' +0.0 -0.15	'K' +0.20	'M' +0.41 -0.0	'Q' +0.20	'S' +0.20	'L' MAX.
10SL	18.21	2.79	14.20	20.60	25.40	95.60
12S	21.40	3.20	14.20	23.60	28.00	95.60
14S	24.61	3.20	14.20	25.40	30.00	95.60
16S	27.41	3.20	14.20	28.60	32.50	95.60
16	27.41	3.20	19.00	28.60	32.50	102.00
18	30.81	3.99	19.00	31.70	35.00	102.00
20	34.19	3.99	19.00	34.90	38.00	102.00
22	37.39	3.99	19.00	31.80	41.00	102.00
24	40.89	3.99	20.60	41.30	44.50	104.00
28	46.71	3.99	20.60	47.60	50.80	104.00
32	53.39	3.99	22.20	54.0	57.00	106.00
36	59.59	3.99	22.20	60.60	63.50	106.00

Cable Connecting Receptacle With SQ Type Shielded B/S & Environmental Sealing Grommet & Heat Shrinkable Option

101SQ

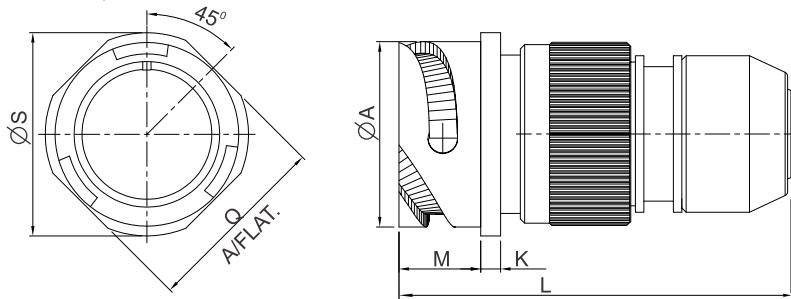

SHELL SIZE	'A' +0.0 -0.15	'K' +0.20	'M' +0.41 -0.0	'Q' +0.20	'S' +0.20	'L' MAX.
10SL	18.21	2.79	14.20	20.60	25.40	57.00
12S	21.40	3.20	14.20	23.60	28.00	57.00
14S	24.61	3.20	14.20	25.40	30.00	59.00
16S	27.41	3.20	14.20	28.60	32.50	59.00
16	27.41	3.20	19.00	28.60	32.50	66.00
18	30.81	3.99	19.00	31.70	35.00	66.00
20	34.19	3.99	19.00	34.90	38.00	66.00
22	37.39	3.99	19.00	31.80	41.00	66.00
24	40.89	3.99	20.60	41.30	44.50	68.00
28	46.71	3.99	20.60	47.60	50.80	68.00
32	53.39	3.99	22.20	54.0	57.00	70.00
36	59.59	3.99	22.20	60.60	63.50	70.00

Cable Connecting Receptacle With Metric Threaded Type B/S Suitable For Metric Glands

101M

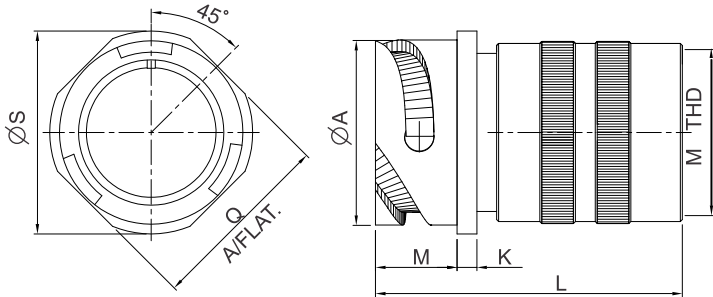

Shell Size	'A' +0.0 -0.15	'K' +0.20	'M' +0.41 - 0.0	'Q' +0.20	'S' ±0.20	'L' MAX.	M THD
10SL	18.21	2.79	14.20	20.60	25.40	56.00	M12X1.5
14s	24.61	3.20	14.20	25.40	30.00	56.00	M16X1.5
16s	27.41	3.20	14.20	28.60	32.50	58.00	M16X1.5
6	27.41	3.20	19.00	28.60	32.50	66.00	M16X1.5
18	30.81	3.99	19.00	31.70	35.00	74.00	M20X1.5
20	34.19	3.99	19.00	34.90	38.00	74.00	M25X1.5
22	37.39	3.99	19.00	31.80	41.00	77.00	M25X1.5
24	40.89	3.99	20.60	41.30	44.50	77.00	M32X1.5
28	46.71	3.99	20.60	47.60	50.80	78.00	M32X1.5
32	53.39	3.99	22.20	54.0	57.00	78.00	M36X1.5
36	59.59	3.99	22.20	60.60	63.50	90.00	M40X1.5

Rear Wall Mount Receptacle With A Type Solid B/S

103A

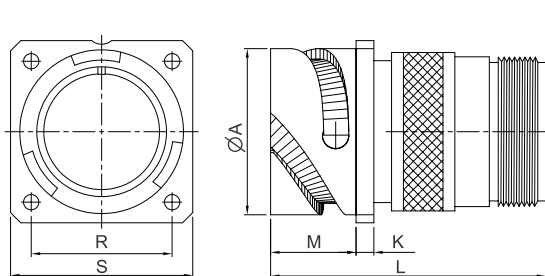

Shell Size	'A' +0.0 -0.15	'K' ±0.20	'M' +0.41 - 0.0	'R' +0.10	'S' ±0.20	'T' THD	'L' MAX
10SL	18.21	2.79	18.20	18.20	25.40	5/8-24 UNEF	45.00
12s	21.40	3.20	18.20	20.60	28.00	5/8-24 UNEF	45.00
14s	24.61	3.20	18.20	23.00	30.00	3/4-20 UNEF	48.00
16s	27.41	3.20	18.20	24.60	32.50	7/8-20 UNEF	48.00
6	27.41	3.20	23.05	24.60	32.50	7/8-20 UNEF	55.00
18	30.81	3.99	23.05	27.00	35.00	1-20 UNEF	60.00
20	34.19	3.99	23.05	29.40	38.00	1 3/16-18UNEF	65.00
22	37.39	3.99	23.05	31.80	41.00	1 3/16-18UNEF	65.00
24	40.89	3.99	23.05	34.90	44.50	1 7/16-18UNEF	68.00
28	46.71	3.99	24.05	39.70	50.80	1 7/16-18UNEF	68.00
32	53.39	3.99	24.05	44.50	57.00	1 3/4-18UNS	70.00
36	59.59	3.99	24.05	49.20	63.50	2-18 UNS	70.00

Rear Wall Mount Receptacle With F Type Strain Relief B/S & Environmental Sealing Grommet

103F

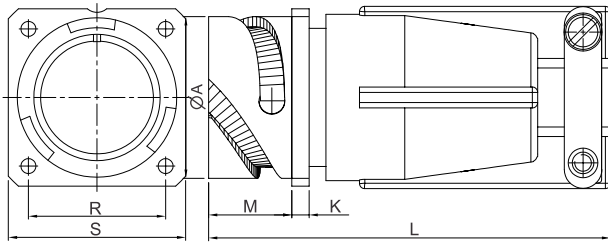

SHELL SIZE	'A' +0.0 -0.15	'K' +/-0.20	'M' +0.41 -0.0	'R' +/-0.10	'S' +/-0.20	'T' THD.	'L' MAX
10SL	18.21	2.79	18.20	18.20	25.40	5/8-24 UNEF	60.00
12S	21.40	3.20	18.20	20.60	28.00	5/8 24 UNEF	60.00
14S	24.61	3.20	18.20	23.00	30.00	3/4-20 UNEF	61.00
16S	27.41	3.20	18.20	24.60	32.50	7/8-20 UNEF	61.00
16	27.41	3.20	23.05	24.60	32.50	7/8-20 UNEF	68.00
18	30.81	3.99	23.05	27.00	35.00	1-20 UNEF	72.00
20	34.19	3.99	23.05	29.40	38.00	1 3/16-18 UNEF	74.00
22	37.39	3.99	23.05	31.80	41.00	1 3/16-18 UNEF	74.00
24	40.89	3.99	23.05	34.90	44.50	1 7/16-18 UNEF	78.00
28	46.71	3.99	24.05	39.70	50.80	1 7/16-18 UNEF	78.00
32	53.39	3.99	24.05	44.50	57.00	1 3/4-18 UNS	82.00
36	59.59	3.99	24.05	49.20	63.50	2-18 UNS	82.00

Rear Wall Mount Receptacle With R Type B/S & Environmental Sealing Grommet

103R

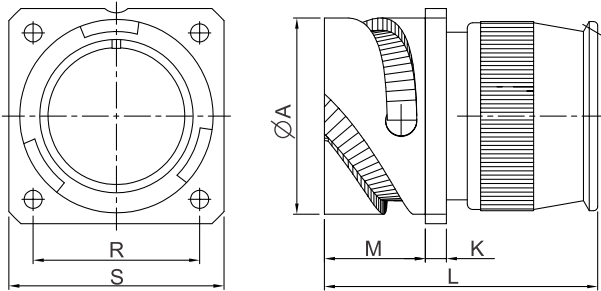

SHELL SIZE	'A' +0.0 -0.15	'K' +/-0.20	'M' +0.41 -0.0	'R'	'S' +/-0.20	'L' MAX.
10SL	18.21	2.79	18.20	18.20	25.40	47.00
12S	21.40	3.20	18.20	20.60	28.00	47.00
14S	24.61	3.20	18.20	23.00	30.00	47.00
16S	27.41	3.20	18.20	24.60	32.50	48.00
16	27.41	3.20	23.05	24.60	32.50	54.40
18	30.81	3.99	23.05	27.00	35.00	56.40
20	34.19	3.99	23.05	29.40	38.00	56.40
22	37.39	3.99	23.05	31.80	41.00	56.40
24	40.89	3.99	23.05	34.90	44.50	57.40
28	46.71	3.99	24.05	39.70	50.80	57.40
32	53.39	3.99	24.05	44.50	57.00	58.10
36	59.59	3.99	24.05	49.20	63.50	58.10

Rear Wall Mount Receptacle With G type B/S for Heat Shrinkable & Environmental Sealing Grommet

103G

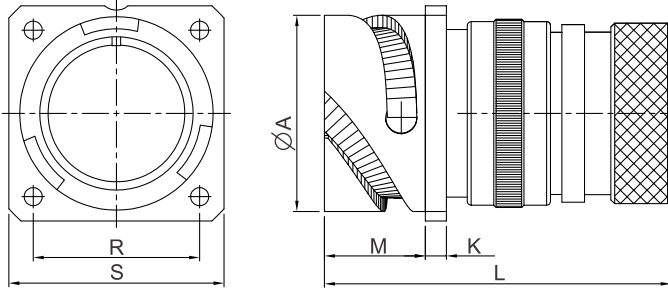

SHELL SIZE	'A' +0.0 -0.15	'K' +/-0.20	'M' +0.41 -0.0	'R' +/-0.10	'S' +/-0.20	'L' MAX.
10SL	18.21	2.79	18.20	18.20	25.40	52.50
12S	21.40	3.20	18.20	20.60	28.00	52.50
14S	24.61	3.20	18.20	23.00	30.00	54.40
16S	27.41	3.20	18.20	24.60	32.50	54.40
16	27.41	3.20	23.05	24.60	32.50	61.00
18	30.81	3.99	23.05	27.00	35.00	62.00
20	34.19	3.99	23.05	29.40	38.00	63.00
22	37.39	3.99	23.05	31.80	41.00	65.00
24	40.89	3.99	23.05	34.90	44.50	65.00
28	46.71	3.99	24.05	39.70	50.80	66.00
32	53.39	3.99	24.05	44.50	57.00	71.00
36	59.59	3.99	24.05	49.20	63.50	75.00

Rear Wall Mount Receptacle With A Type Solid B/S & Environmental Sealing Grommet

103AG

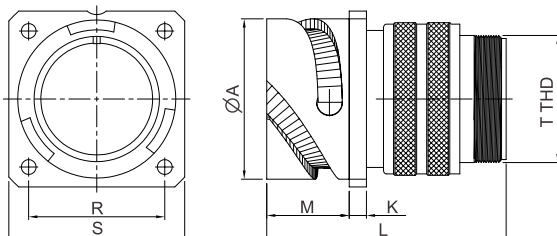

Shell Size	'A' +0.0 -0.15	'K' ±0.20	'M' +0.41 - 0.0	'R' +0.10	'S' ±0.20	'T' THD	'L' MAX
10SL	18.21	2.79	18.20	18.20	25.40	5/8-24 UNEF	68.60
12s	21.40	3.20	18.20	20.60	28.00	5/8-24 UNEF	68.60
14s	24.61	3.20	18.20	23.00	30.00	3/4-20 UNEF	68.60
16s	27.41	3.20	18.20	24.60	32.50	7/8-20 UNEF	68.60
6	27.41	3.20	23.05	24.60	32.50	7/8-20 UNEF	75.00
18	30.81	3.99	23.05	27.00	35.00	1-20 UNEF	75.00
20	34.19	3.99	23.05	29.40	38.00	1 3/16-18UNEF	75.00
22	37.39	3.99	23.05	31.80	41.00	1 3/16-18UNEF	75.00
24	40.89	3.99	23.05	34.90	44.50	1 7/16-18UNEF	77.00
28	46.71	3.99	24.05	39.70	50.80	1 7/16-18UNEF	77.00
32	53.39	3.99	24.05	44.50	57.00	1 3/4-18UNS	80.00
36	59.59	3.99	24.05	49.20	63.50	2-18 UNS	80.00

Rear Wall Mount Receptacle With PG threaded Type B/S Suitable For PG Glands

103PG

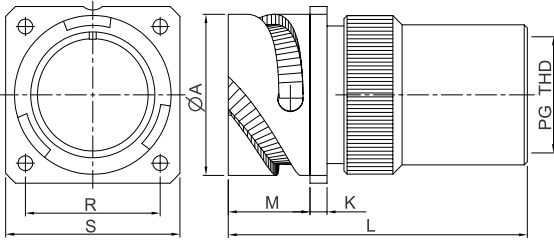

Shell Size	'A' +0.0 -0.15	'K' ±0.20	'M' +0.41 -0.0	'R' +0.10	'S' ±0.20	'L' MAX	PG THD
10SL	18.21	2.79	18.20	18.20	25.40	56.00	7, 9, 11
12s	21.40	3.20	18.20	20.60	28.00	56.00	7, 9, 11
14s	24.61	3.20	18.20	23.00	30.00	56.00	11, 13, 5
16s	27.41	3.20	18.20	24.60	32.50	58.00	9, 11, 16
6	27.41	3.20	23.05	24.60	32.50	66.00	9, 11, 16
18	30.81	3.99	23.05	27.00	35.00	74.00	9, 11, 16, 21
20	34.19	3.99	23.05	29.40	38.00	74.00	11, 16, 21
22	37.39	3.99	23.05	31.80	41.00	77.00	13.5, 16, 21
24	40.89	3.99	23.05	34.90	44.50	77.00	13.5, 16, 21, 29
28	46.71	3.99	24.05	39.70	50.80	78.00	16, 21, 29
32	53.39	3.99	24.05	44.50	57.00	78.00	21, 29
36	59.59	3.99	24.05	49.20	63.50	90.00	21, 29, 36

Rear Wall Mount Receptacle With EGM B/S For Shielded Cable & PHM B/S Unshielded Cable With Sealing Rubber Bush

103 EGM/PHM

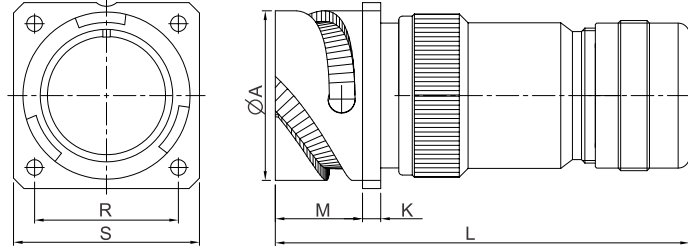

SHELL SIZE	'A' +0.0 -0.15	'K' +0.20	'M' +0.41 -0.0	'R'	'S' +0.20	'L' MAX.
10SL	18.21	2.79	14.20	18.20	25.40	95.60
12S	21.40	3.20	14.20	20.60	28.00	95.60
14S	24.61	3.20	14.20	23.00	30.00	95.60
16S	27.41	3.20	14.20	24.60	32.50	95.60
16	27.41	3.20	19.00	24.60	32.50	102.00
18	30.81	3.99	19.00	27.00	35.00	102.00
20	34.19	3.99	19.00	29.40	38.00	102.00
22	37.39	3.99	19.00	31.80	41.00	102.00
24	40.89	3.99	20.60	34.90	44.50	104.00
28	46.71	3.99	20.60	39.70	50.80	104.00
32	53.39	3.99	22.20	44.50	57.00	106.00
36	59.59	3.99	22.20	49.20	63.50	106.00

Rear Wall Mount Receptacle With SQ Type Shielded B/S & Environmental Sealing Grommet & Heat Shrinkable Option

103SQ

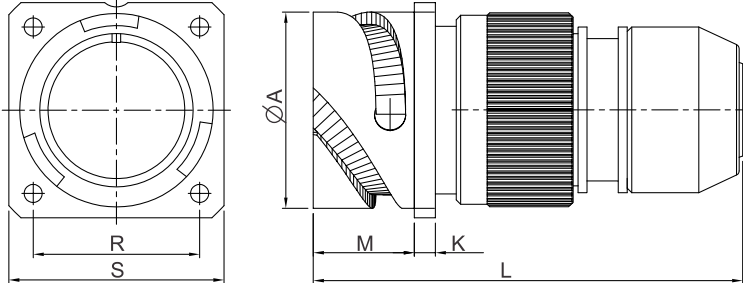

SHELL SIZE	'A' +0.0 -0.15	'K' +0.20	'M' +0.41 -0.0	'R' +0.10	'S' +0.20	'L' MAX.
10SL	18.21	2.79	18.20	18.20	25.40	57.00
12S	21.40	3.20	18.20	20.60	28.00	57.00
14S	24.61	3.20	18.20	23.00	30.00	59.00
16S	27.41	3.20	18.20	24.60	32.50	59.00
16	27.41	3.20	23.05	24.60	32.50	66.00
18	30.81	3.99	23.05	27.00	35.00	66.00
20	34.19	3.99	23.05	29.40	38.00	66.00
22	37.39	3.99	23.05	31.80	41.00	66.00
24	40.89	3.99	23.05	34.90	44.50	68.00
28	46.71	3.99	24.05	39.70	50.80	68.00
32	53.39	3.99	24.05	44.50	57.00	70.00
36	59.59	3.99	24.05	49.20	63.50	70.00

Rear Wall Mount Receptacle With Metric Threaded Type B/S Suitable For Metric Glands

103M

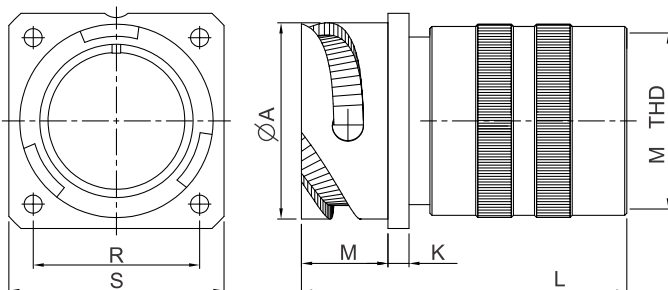

Shell Size	'A' +0.0 -0.15	'K' +0.20	'M' +0.41 -0.0	'R'	'S' ±0.20	'L' MAX.	M THD
10SL	18.21	2.79	18.20	18.20	25.40	56.00	M12X1.5
14s	24.61	3.20	18.20	23.00	30.00	56.00	M16X1.5
16s	27.41	3.20	18.20	24.60	32.50	58.00	M16X1.5
6	27.41	3.20	23.05	24.60	32.50	66.00	M16X1.5
18	30.81	3.99	23.05	27.00	35.00	74.00	M20X1.5
20	34.19	3.99	23.05	29.40	38.00	74.00	M25X1.5
22	37.39	3.99	23.05	31.80	41.00	77.00	M25X1.5
24	40.89	3.99	23.05	34.90	44.50	77.00	M32X1.5
28	46.71	3.99	24.05	39.70	50.80	78.00	M32X1.5
32	53.39	3.99	24.05	44.50	57.00	78.00	M36X1.5
36	59.59	3.99	24.05	49.20	63.50	90.00	M40X1.5

Rear Wall Mount Receptacle With 90° B/S & Environmental Sealing Grommet

103RT

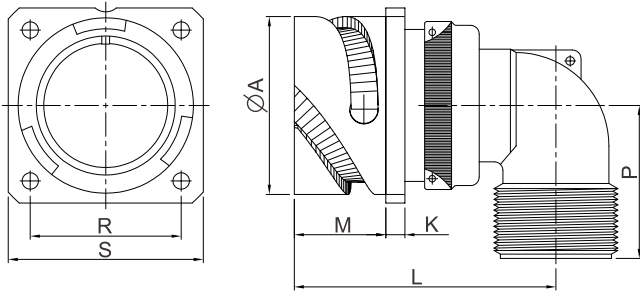

SHELL SIZE	'A' +0.0 -0.15	'K' +0.20	'M' +0.41 -0.0	'R'	'S' +0.20	'L' MAX.	'P' MAX.
10SL	18.21	2.79	14.20	18.20	25.40	40.50	21.50
12S	21.40	3.20	14.20	20.60	28.00	40.50	21.50
14S	24.61	3.20	14.20	23.00	30.00	42.00	23.00
16S	27.41	3.20	14.20	24.60	32.50	45.00	24.60
16	27.41	3.20	19.00	24.60	32.50	52.00	24.60
18	30.81	3.99	19.00	27.00	35.00	53.00	27.00
20	34.19	3.99	19.00	29.40	38.00	58.00	29.00
22	37.39	3.99	19.00	31.80	41.00	58.00	31.00
24	40.89	3.99	20.60	34.90	44.50	63.00	34.00
28	46.71	3.99	20.60	39.70	50.80	63.00	36.00
32	53.39	3.99	22.20	44.50	57.00	69.00	44.00
36	59.59	3.99	22.20	49.20	63.50	72.30	46.00

Straight Plug With A Type Solid B/S

106A

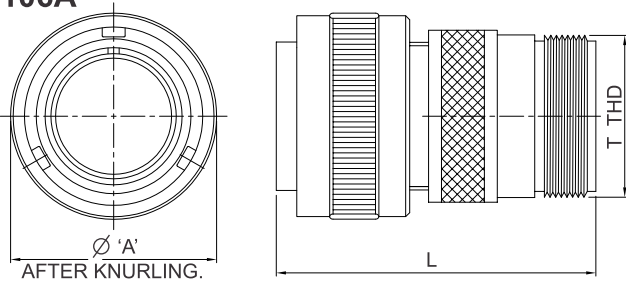

SHELL SIZE	'A' MAX.	'L' MAX.	'T' THD
10SL	22.80	44.00	5/8-24 UNEF
12S	25.60	44.00	5/8-24 UNEF
14S	29.20	46.00	3/4-20 UNEF
16S	32.00	46.00	7/8-20 UNEF
16	32.00	46.00	7/8-20 UNEF
18	36.50	55.00	1-20 UNEF
20	39.39	62.00	1 3/16-18 UNEF
22	46.10	65.00	1 3/16-18 UNEF
24	46.60	65.00	1 7/16-18 UNEF
28	53.40	68.00	1 7/16-18 UNEF
32	60.10	70.00	1 3/4-18 UNS
36	36.30	70.00	2-18 UNS

Rear Wall Mount Receptacle With SQ Type Shielded B/S & Environmental Sealing Grommet

106F

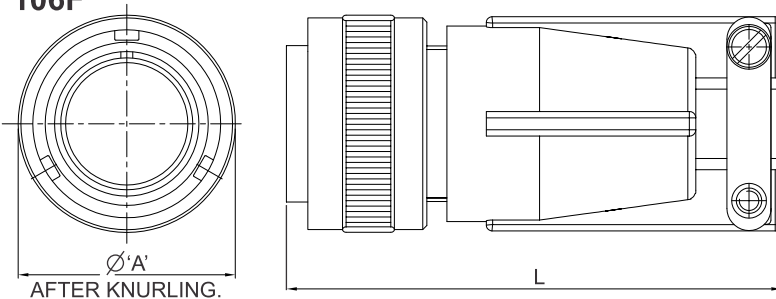

SHELL SIZE	'A' MAX.	'L' MAX	'T' THD.
10SL	22.80	60.00	5/8-24 UNEF
12S	25.60	60.00	5/8-24 UNEF
14S	29.20	60.00	3/4-20 UNEF
16S	32.00	60.00	7/8-20 UNEF
16	32.00	68.00	7/8-20 UNEF
18	36.50	72.00	1-20 UNEF
20	39.90	74.00	1 3/16-18 UNEF
22	43.10	74.00	1 3/16-18 UNEF
24	46.60	78.00	1 7/16-18 UNEF
28	53.40	78.00	1 7/16-18 UNEF
32	60.10	82.00	1 3/4-18 UNS
36	66.30	82.00	2-18 UNS

Straight Plug With R Type B/S & Environmental Sealing Grommet

106R

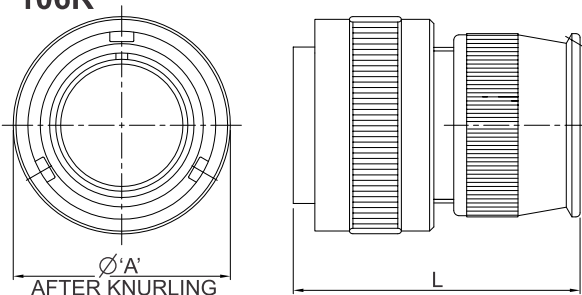

SHELL SIZE	'A' MAX.	'L' MAX.
10SL	22.80	47.00
12S	25.60	47.00
14S	29.20	47.00
16S	32.00	47.00
16	32.00	55.40
18	36.50	57.40
20	39.90	57.40
22	43.10	57.40
24	46.60	57.40
28	53.40	57.40
32	60.10	58.10
36	36.30	58.10

Straight Plug With G Type B/S For Heat Shrinkable & Environmental Sealing Grommet

106G

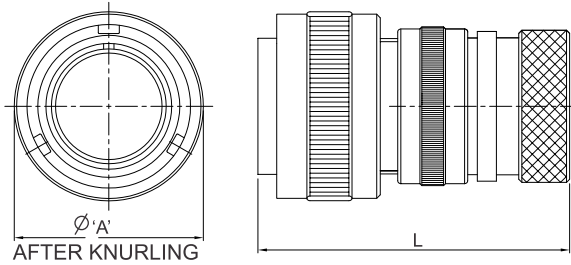

SHELL SIZE	'A' MAX	'L' MAX
10SL	22.80	53.00
12S	25.60	53.00
14S	29.20	53.00
16S	32.00	53.00
16	32.00	61.00
18	36.50	62.00
20	39.90	63.00
22	43.10	65.00
24	46.60	65.00
28	53.40	68.00
32	60.10	71.00
36	66.30	75.00

Straight Plug With A type Solid B/S & Environmental Sealing Grommet

106AG

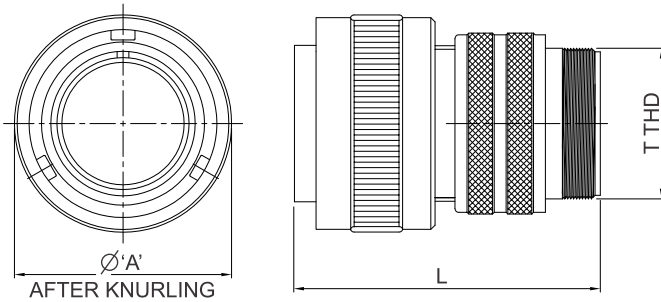

SHELL SIZE	'A' MAX.	'L' MAX.	'T' THD
10SL	22.80	68.60	5/8-24 UNEF
12S	25.60	68.60	5/8-24 UNEF
14S	29.20	67.00	3/4-20 UNEF
16S	32.00	67.00	7/8-20 UNEF
16	32.00	76.00	7/8-20 UNEF
18	36.50	76.00	1-20 UNEF
20	39.90	76.00	1 3/16-18UNEF
22	43.10	76.00	1 3/16-18UNEF
24	46.60	78.00	1 7/16-18UNEF
28	53.40	78.00	1 7/16-18UNEF
32	60.10	80.00	1 3/4-18UNS
36	66.30	80.00	2-18 UNS

Straight Plug With PG Threaded Type B/S Suitable For PG Glands

106PG

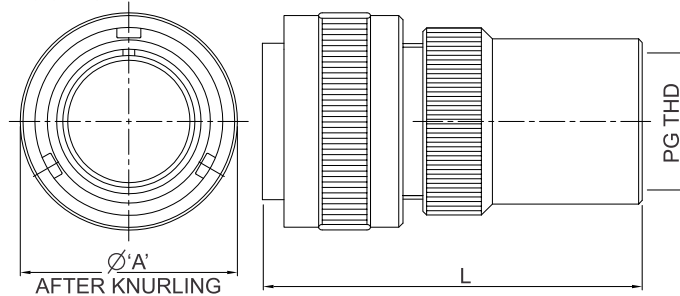

SHELL SIZE	'A' MAX.	'L' MAX	PG THD
10SL	22.80	56.00	7, 9, 11
12S	25.60	56.00	7, 9, 11
14S	29.20	56.00	11, 13.5
16S	32.00	58.00	9, 11, 16
16	32.00	66.00	9, 11, 16
18	36.50	74.00	9, 11, 16, 21
20	39.90	74.00	11, 16, 21
22	43.10	77.00	13.5, 16, 21
24	46.60	77.00	13.5, 16, 21, 29
28	53.40	78.00	16, 21, 29
32	60.10	78.00	21, 29
36	66.30	90.00	21, 29, 36

106 EGM/PHM

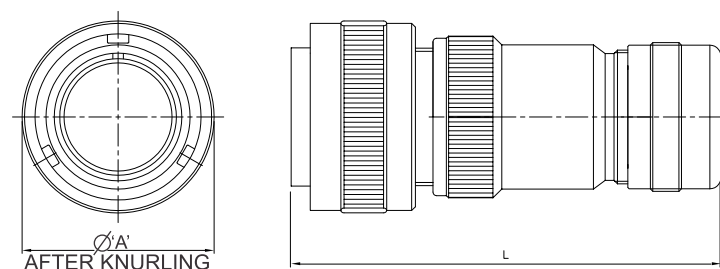

SHELL SIZE	'A' MAX	'L' MAX
10SL	22.80	53.00
12S	25.60	53.00
14S	29.20	53.00
16S	32.00	53.00
16	32.00	61.00
18	36.50	62.00
20	39.90	63.00
22	43.10	65.00
24	46.60	65.00
28	53.40	68.00
32	60.10	71.00
36	66.30	75.00

Straight Plug With SQ Type Shielded B/S & Environmental Sealing Grommet & Heat Shrinkable Option

106SQ

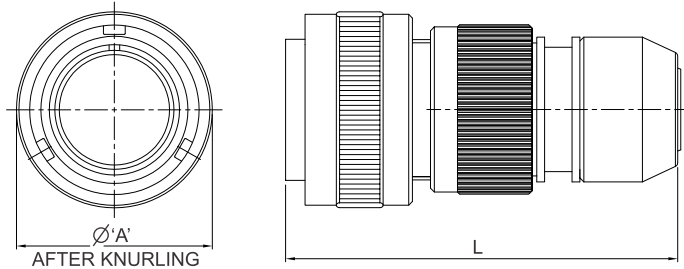

SHELL SIZE	'A' MAX.	'L' MAX.
10SL	22.80	56.60
12S	25.60	56.60
14S	29.20	57.00
16S	32.00	57.00
16	32.00	66.00
18	36.50	66.00
20	39.90	66.00
22	43.10	66.00
24	46.60	68.00
28	53.40	66.00
32	60.10	70.00
36	66.30	70.00

Straight Plug With Metric Threaded Type B/S Suitable For Metric Glands

106M

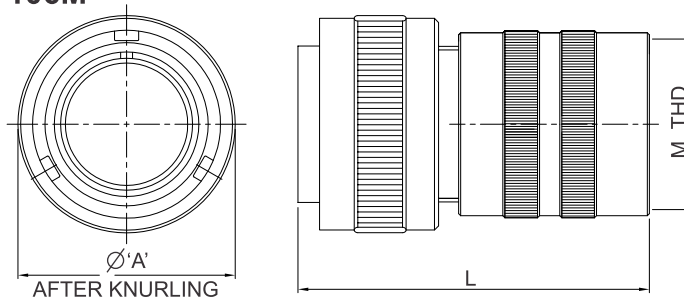

Shell Size	'A' MAX.	'L' MAX.	M THD
10SL	22.80	56.00	M12X1.5
14s	29.20	56.00	M16X1.5
16s	32.00	58.00	M16X1.5
6	32.00	66.00	M16X1.5
18	36.50	74.00	M20X1.5
20	39.90	74.00	M25X1.5
22	43.10	77.00	M25X1.5
24	46.60	77.00	M32X1.5
28	53.40	78.00	M32X1.5
32	60.10	78.00	M36X1.5
36	66.30	90.00	M40X1.5

Jam Nut Receptacle With A Type Solid B/S

107A

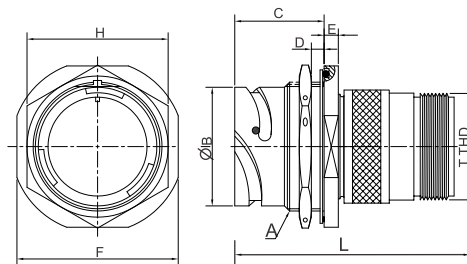

SHELL SIZE	A -2A THREADS	B +0.0 -0.15	C	D WALL THICKNESS		E	F +0.25	H	L
				MIN	MAX				
10SL	7/8" - 20 UNEF	18.20	24.50	2.40	5.20	4.00	31.80	27.00	52.00
14S	1" 1/8-18 UNEF	24.60	26.80	2.40	7.50	4.80	41.30	33.00	58.00
16S	1" 1/4-18 UNEF	27.40	26.80	2.40	7.50	4.80	44.40	38.10	58.00
16	1" 1/4-18 UNEF	27.40	32.10	2.40	7.50	4.80	44.40	38.10	68.00
18	1" 3/8-18 UNEF	30.80	33.70	2.40	9.00	4.80	47.60	39.70	76.00
20	1" 1/2-18 UNEF	34.20	33.70	2.40	9.00	4.80	50.80	44.00	80.00
22	1" 5/8-18 UNEF	37.40	33.70	2.40	9.10	4.80	54.20	46.00	80.00
24	1" 3/4-18 UNS	40.90	33.70	2.40	9.10	4.80	57.20	50.80	82.00
28	2" - 18 UNS	46.70	35.20	2.40	8.50	5.60	63.50	55.00	84.00
32	2" 1/4-16 UN	53.40	35.20	2.40	6.50	5.60	69.80	62.00	85.00
36	2" 1/2-16 UN	59.60	35.20	2.40	8.30	5.60	76.20	71.00	85.00

Jam Nut Receptacle With F Type Strain Relief B/S With Environmental Sealing Grommet

107F

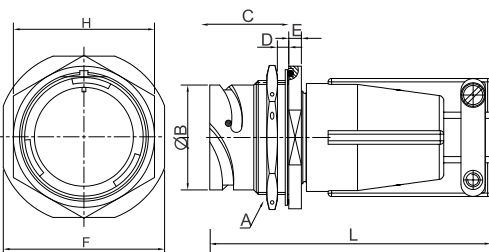

SHELL SIZE	A -2A THREADS	B +0.0 -0.15	C	D WALL THICKNESS		E	F +0.25	H	L
				MIN	MAX				
10SL	7/8" - 20 UNEF	18.20	24.50	2.40	5.20	4.00	31.80	27.00	69.00
14S	1" 1/8-18 UNEF	24.60	26.80	2.40	7.50	4.80	41.30	33.00	72.00
16S	1" 1/4-18 UNEF	27.40	26.80	2.40	7.50	4.80	44.40	38.10	72.00
16	1" 1/4-18 UNEF	27.40	32.10	2.40	7.50	4.80	44.40	38.10	83.00
18	1" 3/8-18 UNEF	30.80	33.70	2.40	9.00	4.80	47.60	39.70	87.00
20	1" 1/2-18 UNEF	34.20	33.70	2.40	9.00	4.80	50.80	44.00	89.00
22	1" 5/8-18 UNEF	37.40	33.70	2.40	9.10	4.80	54.20	46.00	89.00
24	1" 3/4-18 UNS	40.90	33.70	2.40	9.10	4.80	57.20	50.80	92.00
28	2" - 18 UNS	46.70	35.20	2.40	8.50	5.60	63.50	55.00	95.00
32	2" 1/4-16 UN	53.40	35.20	2.40	6.50	5.60	69.80	62.00	97.00
36	2" 1/2-16 UN	59.60	35.20	2.40	8.30	5.60	76.20	71.00	97.00

Jam Nut Receptacle With R Type B/S With Environmental Sealing Grommet

107R

SHELL SIZE	A -2A THREADS	B +0.0 -0.15	C	D WALL THICKNESS		E	F +0.25	H	L
				MIN	MAX				
10SL	7/8" - 20 UNEF	18.20	24.50	2.40	5.20	4.00	31.80	27.00	56.00
14S	1" 1/8-18 UNEF	24.60	26.80	2.40	7.50	4.80	41.30	33.00	59.00
16S	1" 1/4-18 UNEF	27.40	26.80	2.40	7.50	4.80	44.40	38.10	70.00
16	1" 1/4- 18 UNEF	27.40	32.10	2.40	7.50	4.80	44.40	38.10	72.00
18	1" 3/8- 18 UNEF	30..80	33.70	2.40	9.00	4.80	47.60	39.70	72.00
20	1" 1/2- 18 UNEF	34.20	33.70	2.40	9.00	4.80	50.80	44.00	72.00
22	1" 5/8- 18 UNEF	37.40	33.70	2.40	9.10	4.80	54.20	46.00	72.00
24	1" 3/4- 18 UNS	40.90	33.70	2.40	9.10	4.80	57.20	50.80	72.00
28	2" - 18 UNS	46.70	35.20	2.40	8.50	5.60	63.50	55.00	74.00
32	2" 1/4- 16 UN	53.40	35.20	2.40	6.50	5.60	69.80	62.00	74.00
36	2" 1/2- 16 UN	59.60	35.20	2.40	8.30	5.60	76.20	71.00	74.00

Jam Nut Receptacle With G Type B/S For Heat shrinkable & Environmental Sealing Grommet

107G

Shell Size	'A' -2A Threads	'B' +0.00 - 0.15	'C'	D Wall Thickness		E	F +0.25	H	L
				MIN.	MAX.				
10SL	7/8"-20UNEF	18.20	24.50	2.40	5.20	4.00	31.80	27.00	61.00
14S	1" 1/8-18UNEF	24.60	26.80	2.40	7.50	4.80	41.30	33.00	66.00
16S	1" 1/4-18UNEF	27.40	26.80	2.40	7.50	4.80	44.40	38.10	66.00
16	1" 1/4-18UNEF	27.40	32.10	2.40	7.50	4.80	44.40	38.10	76.00
18	1" 3/8-18UNEF	30.80	33.70	2.40	9.00	4.80	47.60	39.70	78.00
20	1" 1/2-18UNEF	34.20	33.70	2.40	9.00	4.80	50.80	44.00	79.00
22	1" 5/8-18UNEF	37.40	33.70	2.40	9.10	4.80	54.20	46.00	81.00
24	1" 3/4-18UNS	40.90	33.70	2.40	9.10	4.80	57.20	50.80	79.00
28	2"-18UNS	46.70	35.20	2.40	8.50	5.60	63.50	55.00	82.00
32	2" 1/4-16UN	53.40	35.20	2.40	6.50	5.60	69.80	62.00	85.00
36	2" 1/2-16UN	59.60	35.20	2.40	8.30	5.60	76.20	71.00	90.00

Jam Nut Receptacle With AG type B/S For Heat Shrinkable & Environmental Sealing Grommet

107AG

SHELL SIZE	A -2A THREADS	B +0.0 -0.15	C	D WALL THICKNESS		E	F +0.25	H	L
				MIN	MAX				
10SL	7/8" - 20 UNEF	18.20	24.50	2.40	5.20	4.00	31.80	27.00	77.00
14S	1" 1/8-18 UNEF	24.60	26.80	2.40	7.50	4.80	41.30	33.00	80.00
16S	1" 1/4-18 UNEF	27.40	26.80	2.40	7.50	4.80	44.40	38.10	80.00
16	1" 1/4- 18 UNEF	27.40	32.10	2.40	7.50	4.80	44.40	38.10	90.00
18	1" 3/8- 18 UNEF	30..80	33.70	2.40	9.00	4.80	47.60	39.70	92.00
20	1" 1/2- 18 UNEF	34.20	33.70	2.40	9.00	4.80	50.80	44.00	92.00
22	1" 5/8- 18 UNEF	37.40	33.70	2.40	9.10	4.80	54.20	46.00	92.00
24	1" 3/4- 18 UNS	40.90	33.70	2.40	9.10	4.80	57.20	50.80	92.00
28	2" - 18 UNS	46.70	35.20	2.40	8.50	5.60	63.50	55.00	94.00
32	2" 1/4- 16 UN	53.40	35.20	2.40	6.50	5.60	69.80	62.00	94.00
36	2" 1/2- 16 UN	59.60	35.20	2.40	8.30	5.60	76.20	71.00	94.00

Jam Nut Receptacle With PG Threaded Type B/S Suitable For PG Glands

107PG

SHELL SIZE	A -2A THREADS	B +0.0 -0.15	C	D WALL THICKNESS		E	F +0.25	H	L	PG THD
				MIN	MAX					
10SL	7/8" - 20 UNEF	18.20	24.50	2.40	5.20	4.00	31.80	27.00	64.60	7, 9,11
14S	1" 1/8-18 UNEF	24.60	26.80	2.40	7.50	4.80	41.30	33.00	68.00	11,13,5
16S	1" 1/4-18 UNEF	27.40	26.80	2.40	7.50	4.80	44.40	38.10	70.00	9,11,16
16	1" 1/4- 18 UNEF	27.40	32.10	2.40	7.50	4.80	44.40	38.10	81.00	9,11,16
18	1" 3/8- 18 UNEF	30..80	33.70	2.40	9.00	4.80	47.60	39.70	89.00	9,11,16,21
20	1" 1/2- 18 UNEF	34.20	33.70	2.40	9.00	4.80	50.80	44.00	90.00	11,16,21
22	1" 5/8- 18 UNEF	37.40	33.70	2.40	9.10	4.80	54.20	46.00	93.00	13,5,16,21
24	1" 3/4- 18 UNS	40.90	33.70	2.40	9.10	4.80	57.20	50.80	91.00	13,5,16,21
28	2" - 18 UNS	46.70	35.20	2.40	8.50	5.60	63.50	55.00	95.00	16,21,29
32	2" 1/4- 16 UN	53.40	35.20	2.40	6.50	5.60	69.80	62.00	94.00	21,29
36	2" 1/2- 16 UN	59.60	35.20	2.40	8.30	5.60	76.20	71.00	105.00	21,29,36

Jam Nut Receptacle With EGM B/S For Shielded Cable & PHM B/S Unshielded Cable With Sealing Rubber Bush

107EGM/PHM

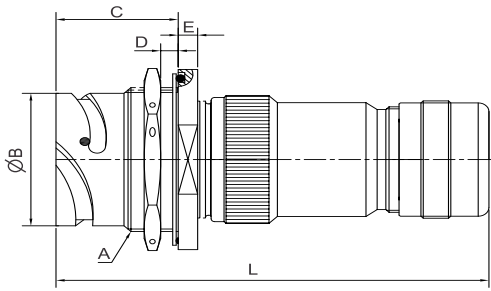

SHELL SIZE	A -2A THREADS	B +0.0 -0.15	C	D WALL THICKNESS		E	F +0.25	H	L
				MIN	MAX				
10SL	7/8" - 20 UNEF	18.20	24.50	2.40	5.20	4.00	31.80	27.00	104.20
14S	1" 1/8-18 UNEF	24.60	26.80	2.40	7.50	4.80	41.30	33.00	107.00
16S	1" 1/4-18 UNEF	27.40	26.80	2.40	7.50	4.80	44.40	38.10	107.00
16	1" 1/4- 18 UNEF	27.40	32.10	2.40	7.50	4.80	44.40	38.10	107.00
18	1" 3/8- 18 UNEF	30.80	33.70	2.40	9.00	4.80	47.60	39.70	118.00
20	1" 1/2- 18 UNEF	34.20	33.70	2.40	9.00	4.80	50.80	44.00	118.00
22	1" 5/8- 18 UNEF	37.40	33.70	2.40	9.10	4.80	54.20	46.00	118.00
24	1" 3/4- 18 UNS	40.90	33.70	2.40	9.10	4.80	57.20	50.80	118.00
28	2" - 18 UNS	46.70	35.20	2.40	8.50	5.60	63.50	55.00	120.00
32	2" 1/4- 16 UN	53.40	35.20	2.40	6.50	5.60	69.80	62.00	120.00
36	2" 1/2- 16 UN	59.60	35.20	2.40	8.30	5.60	76.20	71.00	120.00

Jam Nut Receptacle With SQ type Shielded B/S & Environmental Sealing Grommet & Heat Shrinkable Option

107SQ

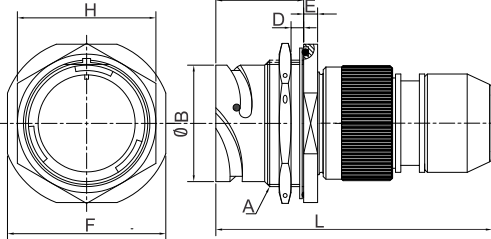

SHELL SIZE	A -2A THREADS	B +0.0 -0.15	C	D WALL THICKNESS		E	F +0.25	H	L
				MIN	MAX				
10SL	7/8" - 20 UNEF	18.20	24.50	2.40	5.20	4.00	31.80	27.00	66.00
14S	1" 1/8-18 UNEF	24.60	26.80	2.40	7.50	4.80	41.30	33.00	70.20
16S	1" 1/4-18 UNEF	27.40	26.80	2.40	7.50	4.80	44.40	38.10	70.20
16	1" 1/4- 18 UNEF	27.40	32.10	2.40	7.50	4.80	44.40	38.10	80.00
18	1" 3/8- 18 UNEF	30.80	33.70	2.40	9.00	4.80	47.60	39.70	81.00
20	1" 1/2- 18 UNEF	34.20	33.70	2.40	9.00	4.80	50.80	44.00	81.00
22	1" 5/8- 18 UNEF	37.40	33.70	2.40	9.10	4.80	54.20	46.00	82.00
24	1" 3/4- 18 UNS	40.90	33.70	2.40	9.10	4.80	57.20	50.80	82.00
28	2" - 18 UNS	46.70	35.20	2.40	8.50	5.60	63.50	55.00	84.00
32	2" 1/4- 16 UN	53.40	35.20	2.40	6.50	5.60	69.80	62.00	84.00
36	2" 1/2- 16 UN	59.60	35.20	2.40	8.30	5.60	76.20	71.00	84.00

Jam Nut Receptacle With Metric Threaded Type B/S Suitable For Metric Glands

107M

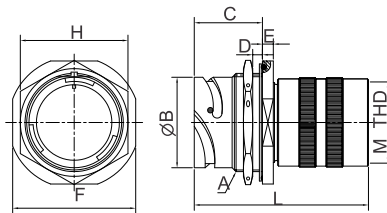

SHELL SIZE	A -2A THREADS	B +0.0 -0.15	C	D WALL THICKNESS		E	F +0.25	H	L	M THD
				MIN	MAX					
10SL	7/8" - 20 UNEF	18.20	24.50	2.40	5.20	4.00	31.80	27.00	66.00	M12X1.5
14S	1" 1/8-18 UNEF	24.60	26.80	2.40	7.50	4.80	41.30	33.00	70.20	M16X1.5
16S	1" 1/4-18 UNEF	27.40	26.80	2.40	7.50	4.80	44.40	38.10	70.20	M16X1.5
16	1" 1/4- 18 UNEF	27.40	32.10	2.40	7.50	4.80	44.40	38.10	80.00	M16X1.5
18	1" 3/8- 18 UNEF	30.80	33.70	2.40	9.00	4.80	47.60	39.70	81.00	M20X1.5
20	1" 1/2- 18 UNEF	34.20	33.70	2.40	9.00	4.80	50.80	44.00	81.00	M25X1.5
22	1" 5/8- 18 UNEF	37.40	33.70	2.40	9.10	4.80	54.20	46.00	82.00	M25X1.5
24	1" 3/4- 18 UNS	40.90	33.70	2.40	9.10	4.80	57.20	50.80	82.00	M32X1.5
28	2" - 18 UNS	46.70	35.20	2.40	8.50	5.60	63.50	55.00	84.00	M32X1.5
32	2" 1/4- 16 UN	53.40	35.20	2.40	6.50	5.60	69.80	62.00	84.00	M36X1.5
36	2" 1/2- 16 UN	59.60	35.20	2.40	8.30	5.60	76.20	71.00	84.00	M40X1.5

Jam Nut Receptacle With 90° B/S & Environmental Sealing Grommet

107RT

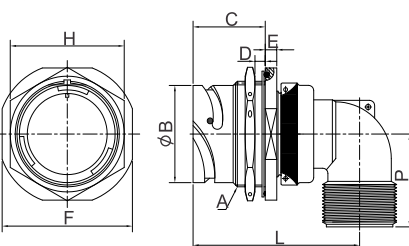

SHELL SIZE	A -2A THREADS	B +0.0 -0.15	C	D WALL THICKNESS		E	F +0.25	H	L	'P' MAX.
				MIN	MAX					
10SL	7/8" - 20 UNEF	18.20	24.50	2.40	5.20	4.00	31.80	27.00	49.00	21.50
14S	1" 1/8-18 UNEF	24.60	26.80	2.40	7.50	4.80	41.30	33.00	54.00	23.00
16S	1" 1/4-18 UNEF	27.40	26.80	2.40	7.50	4.80	44.40	38.10	57.00	24.60
16	1" 1/4- 18 UNEF	27.40	32.10	2.40	7.50	4.80	44.40	38.10	66.00	24.60
18	1" 3/8- 18 UNEF	30.80	33.70	2.40	9.00	4.80	47.60	39.70	69.00	27.00
20	1" 1/2- 18 UNEF	34.20	33.70	2.40	9.00	4.80	50.80	44.00	75.00	29.00
22	1" 5/8- 18 UNEF	37.40	33.70	2.40	9.10	4.80	54.20	46.00	75.00	31.00
24	1" 3/4- 18 UNS	40.90	33.70	2.40	9.10	4.80	57.20	50.80	77.00	34.00
28	2" - 18 UNS	46.70	35.20	2.40	8.50	5.60	63.50	55.00	80.00	36.00
32	2" 1/4- 16 UN	53.40	35.20	2.40	6.50	5.60	69.80	62.00	84.00	44.00
36	2" 1/2- 16 UN	59.60	35.20	2.40	8.30	5.60	76.20	71.00	87.00	46.00

90° Plug Connector

108A=Supplied without grommet
108R=Supplied with grommet

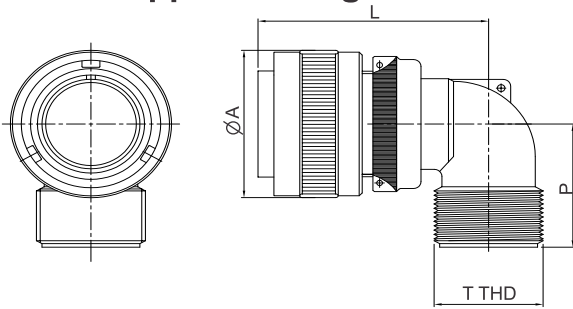

SHELL SIZE	'A' MAX.	'L' MAX.	'P' MAX.	'T' THD
10SL	22.80	41.00	21.50	5/8-24 UNEF
12S	25.60	41.00	21.50	5/8-24 UNEF
14S	29.20	41.00	23.00	3/4-20 UNEF
16S	32.00	43.00	24.60	7/8-20 UNEF
16	32.00	53.00	24.60	7/8-20 UNEF
18	36.50	55.00	27.00	1-20 UNEF
20	39.90	60.00	29.00	1 3/16-18 UNEF
22	43.10	60.00	31.00	1 3/16-18 UNEF
24	46.60	64.00	34.00	1 7/16-18 UNEF
28	53.40	64.00	36.00	1 7/16-18 UNEF
32	60.10	70.00	44.00	1 3/4-18 UNS
36	66.30	74.00	46.00	2-18 UNS

90° Plug Connector With G type B/S For Heat Shrinkable & Environmental Sealing Grommet

108G

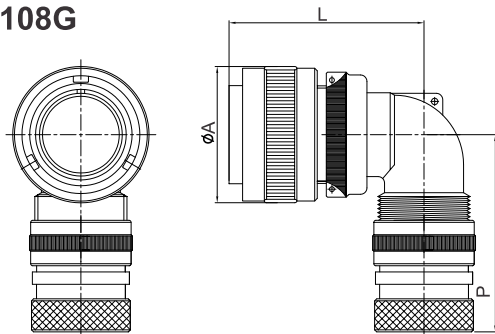

SHELL SIZE	'A' MAX	'L' MAX	'P' MAX
10SL	22.80	41.00	46.00
12S	25.60	41.00	46.20
14S	29.20	41.00	50.00
16S	32.00	43.00	52.00
16	32.00	53.00	52.00
18	36.50	55.00	55.00
20	39.90	60.00	58.00
22	43.10	60.00	62.00
24	46.60	64.00	63.00
28	53.40	64.00	65.00
32	60.10	76.00	76.00

90° Plug Connector With Strain Relief B/S & Environmental Sealing Grommet

108F

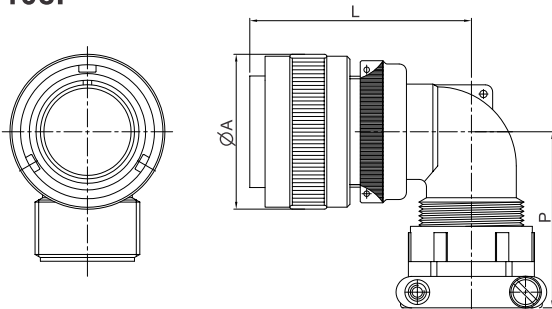

SHELL SIZE	'A' MAX.	'L' MAX.	'P' MAX.
10SL	22.80	41.00	38.00
12S	25.60	41.00	40.00
14S	29.20	43.00	41.00
16S	32.00	53.00	45.00
16	32.00	55.00	45.00
18	36.50	60.00	48.00
20	39.90	60.00	50.00
22	46.10	64.00	52.00
24	46.60	64.00	56.00
28	53.40	70.00	58.00
32	60.10	70.00	68.00
36	36.30	74.00	70.00

90° Plug Connector With PG threaded Type B/S Suitable For PG Glands

108PG

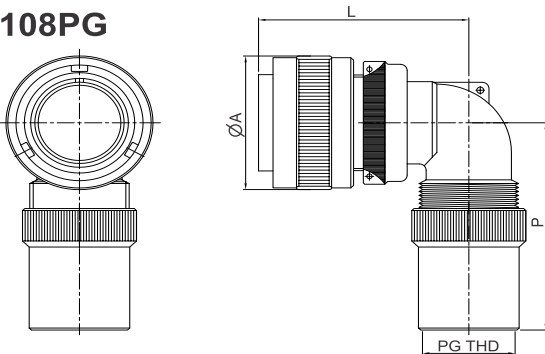

SHELL SIZE	'A' MAX.	'L' MAX.	'P' MAX.	PG THD
10SL	22.80	41.00	50.00	7, 9, 11
12S	25.60	41.00	50.00	7, 9, 11
14S	29.20	41.00	52.00	11, 13.5
16S	32.00	43.00	55.00	9, 11, 16
16	32.00	53.00	57.00	9, 11, 16
18	36.50	55.00	67.00	9, 11, 16, 21
20	39.90	60.00	69.00	11, 16, 21
22	43.10	60.00	74.00	13.5, 16, 21
24	46.60	64.00	75.00	13.5, 16, 21, 29
28	53.40	64.00	78.00	16, 21, 29
32	60.10	70.00	85.00	21, 29
36	66.30	74.00	98.00	21, 29, 36

90° Plug Connector With EGM B/S For Shielded Cable & PHM B/S Unshielded Cable With Sealing Rubber Bush 108EGM/PHM

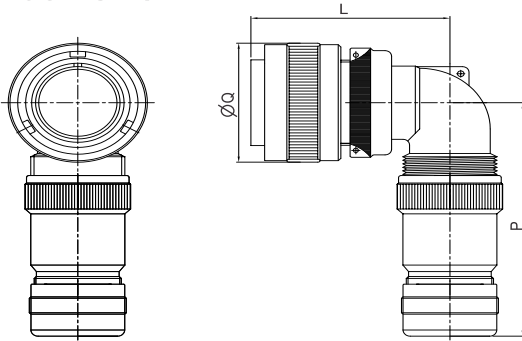

SHELL SIZE	'A' MAX.	'L' MAX.	'P' MAX.
10SL	22.80	41.00	91.00
12S	25.60	41.00	91.00
14S	29.20	41.00	91.00
16S	32.00	43.00	93.00
16	32.00	53.00	93.00
18	36.50	55.00	95.00
20	39.90	60.00	97.00
22	43.10	60.00	99.00
24	46.60	64.00	102.00
28	53.40	64.00	103.00
32	60.10	70.00	111.00
36	66.30	74.00	113.00

90° Plug Connector With SQ type Shielded B/S & Environmental Sealing Grommet & Heat Shrinkable Option 108SQ

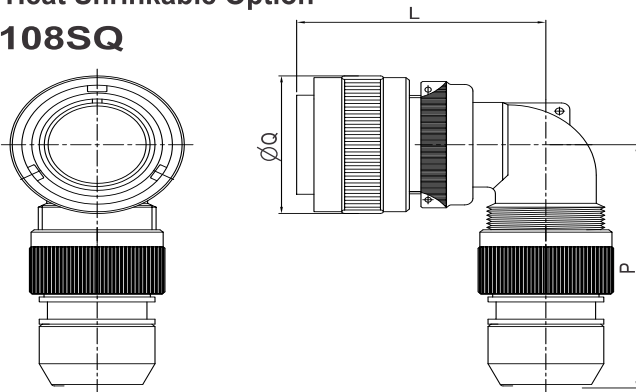

SHELL SIZE	'A' MAX.	'L' MAX.	'P' MAX.
10SL	22.80	41.00	49.00
12S	25.60	41.00	51.00
14S	29.20	41.00	55.00
16S	32.00	43.00	56.00
16	32.00	53.00	56.00
18	36.50	55.00	59.00
20	39.90	60.00	60.00
22	43.10	60.00	63.00
24	46.60	64.00	66.00
28	53.40	64.00	67.00
32	60.10	70.00	75.00
36	66.30	74.00	77.00

90° Plug Connector With Metric Threaded Type B/S Suitable For Metric Glands 108M

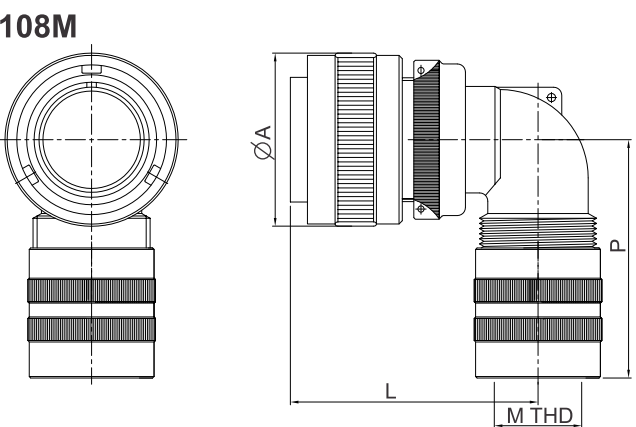

Shell Size	'A' MAX.	'L' MAX.	'P' MAX.	M THD
10SL	22.80	41.00	49.50	M12X1.5
14s	29.20	41.00	49.50	M16X1.5
16s	32.00	43.00	49.50	M16X1.5
6	32.00	53.00	52.00	M16X1.5
18	36.50	55.00	63.00	M20X1.5
20	39.90	60.00	65.00	M25X1.5
22	43.10	60.00	67.00	M25X1.5
24	46.60	64.00	73.00	M32X1.5
28	53.40	64.00	75.00	M32X1.5
32	60.10	70.00	85.00	M36X1.5
36	66.30	74.00	98.00	M40X1.5

Panel Mounting Plug Connector 97B - 3164 97B-4164

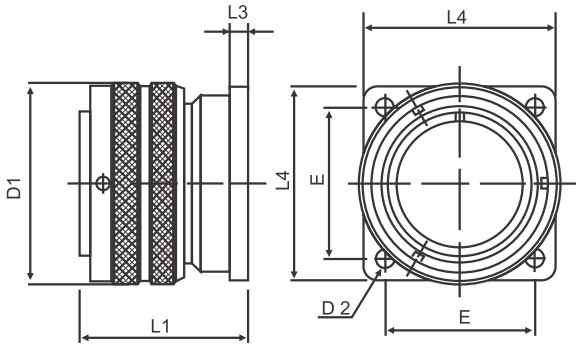

All dimensions are in mm

Shell Size	D ₁ Max	D ₂ H13	E ±0.1	L ₁ ~	L ₃ ±0.2	L ₄ ±0.3
10SL	22.8	3.2	18.2	28.1	2.8	25.4
14S	29.2	3.2	23	28.1	3.2	30
16S	32	3.2	24.6	28.1	3.2	32.5
16	32	3.2	24.6	37.6	3.2	32.5
18	36.5	3.2	27	38.6	4	35
20	39.9	3.2	29.4	38.6	4	38
22	43.1	3.2	31.8	38.6	4	41
24	46.6	3.7	34.9	41	4	44.5
28	53.4	3.7	39.7	41.8	4	50.8
32	60.1	4.3	44.5	45	4	57
36	66.3	4.3	49.2	45	4	63.5
40	72.5	4.3	55.5	45	4	69.9

Back Accessory

Back Accessories Cable Clamp MS-3057 Use MS-3420 Sleeves

All dimensions are in mm

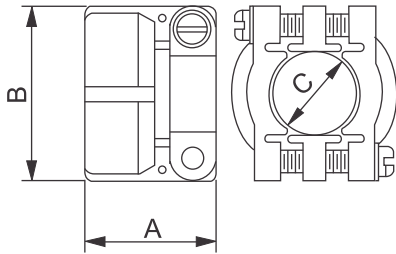

Part number	Shell size	Max OD of cable	A	B	C	Thread in inches
MS-3057-4A	10SL, 12S	5.59	20.90	21.39	7.94	5/8-24
MS-3057-6A	14, 14S	7.92	21.59	25.27	11.11	3/4-20
MS-3057-8A	16, 16S	11.10	23.37	28.45	14.29	7/8-20
MS-3057-10A	18	14.27	23.37	30.89	15.87	1-20
MS-3057-12A	20, 22	15.87	23.07	35.03	19.50	1 3/16-18
MS-3057-16A	24, 28	19.05	25.78	42.75	23.81	1 7/16-18
MS-3057-20A	32	23.80	28.00	51.00	31.70	1 3/4-18
MS-3057-24A	36	31.75	29.36	57.02	34.92	2-18

Back Accessories Cable Clamp MS-3057/C Style

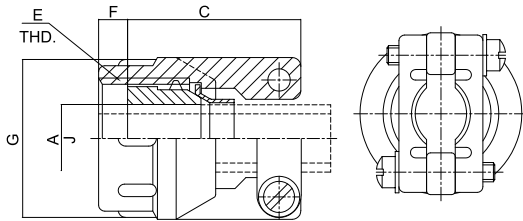

CONN. SIZE	MS. P/NO.	Ø'A' MAX. CABLE	Ø'J' CLOSED	'C' MAX.	'E' THREAD CLASS 2B	'F' MIN.	Ø'G' ±0.41	'H' MAX.
10SL 12, 12S	MS3057-4C	7.67	2.39	23.82	0.625-24UNEF	9.52	21.44	23.01
14, 14S	MS3057-6C	10.87	5.84	23.82	0.750-20UNEF	↓	24.61	26.19
16, 16S	MS3057-8C	13.08	8.02	23.82	0.875-20UNEF	↓	27.79	28.57
18	MS3057-10C	15.60	9.60	25.81	1.000-20UNEF	↓	30.96	31.34
20, 22	MS3057-12C	18.74	11.30	26.19	1.1875-18UNEF	↓	35.71	37.69
24, 28	MS3057-16C	23.52	15.52	28.98	1.4375-18UNEF	9.52	42.06	42.44
32	MS3057-20C	30.48	23.42	33.73	1.750-18UNS	11.12	50.8	55.57
36	MS3057-24C	34.62	23.42	38.89	2.000-18UNS	12.70	57.15	59.54
40	MS3057-28C	40.92	29.97	38.89	2.250-16UN	12.70	63.50	65.89

Neoprene Sleeve

MS-3420

Rubber Bushing Protects Wire Bundles And Unjacketed Cables From Possible Damage By Cable Clamp

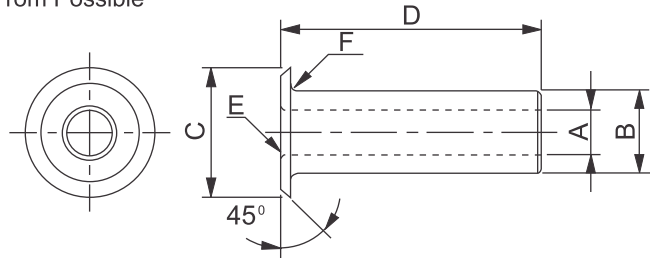

All dimensions are in mm

Part number	A	B	C	D	E Rad in inches	F Rad in inches
MS-3420-3	3.30	5.33	9.50	73.02	0.79	0.79
MS-3420-4	5.59	7.67	12.70	69.85	0.79	0.79
MS-3420-6	7.92	10.84	15.59	66.67	0.79	1.59
MS-3420-8	11.10	14.02	18.77	63.50	1.59	1.59
MS-3420-10	14.27	15.62	21.94	60.32	1.59	1.59
MS-3420-12	15.87	18.80	26.23	56.20	1.59	1.59
MS-3420-16	19.05	23.54	26.39	53.97	1.59	1.59
MS-3420-20	23.80	31.50	40.41	50.80	1.59	1.59
MS-3420-24	31.75	34.67	46.79	47.62	1.59	1.59

Plain Flat Gasket

For MS & 97B Flange Mounted Receptacles

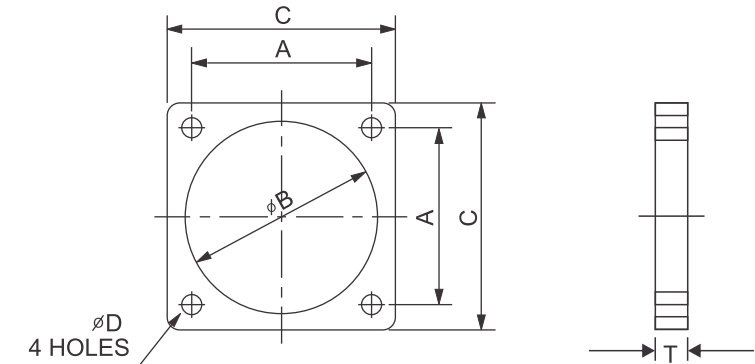

All dimensions are in mm

Part number	Shell size	A max	B	C	D	T
MS-101000	10SL	18.26	15.90	25.40	4.35	1.5
MS-108686	12S & 12	20.62	19.05	27.80	4.35	1.5
MS-101001	14S & 14	23.01	22.20	30.15	4.35	1.5
MS-101002	16S & 16	24.61	25.40	32.50	4.35	1.5
MS-101003	18	27.00	28.57	34.90	5.15	1.5
MS-101004	20	29.36	31.75	38.10	5.15	1.5
MS-101005	22	31.75	34.90	41.20	5.15	1.5
MS-108687	24	34.90	38.10	44.45	5.15	1.5
MS-101006	28	39.70	44.45	50.80	5.15	1.5
MS-108688	32	44.45	50.80	57.15	5.55	1.5
MS-101007	36	49.22	55.57	63.50	5.55	1.5
MS-110831	40	55.77	61.92	69.85	5.55	1.5

For Plugs
97B-25042-XX-YY
XX-Shell Size
YY-Plating Finish
(Ref. Page 40 For Plating Finish)

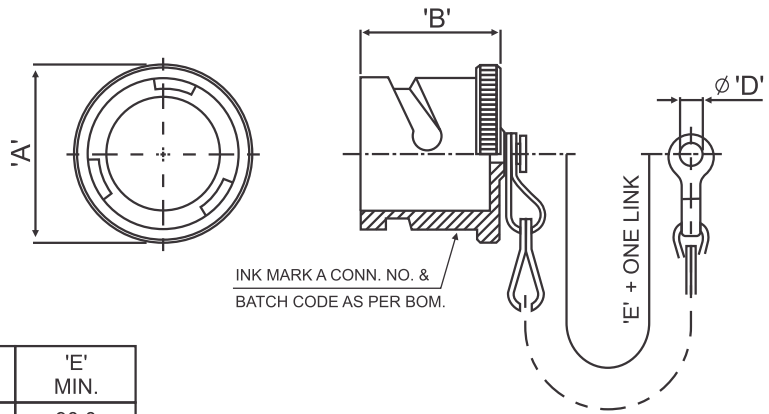

All dimensions are in mm

SHELL SIZE	'A' MAX.	'B' MAX.	'D' + 0.60/-0	'E' MIN.
10 SL	21.0	23.50	4.30	90.0
14 S	27.50			100.0
16 S	30.0	31.50	4.70	115.0
16				100.0
18	33.50			115.0
20	37.0			130.0
22	40.0	5.50	190.0	130.0
24	43.0			190.0
28	49.50	5.50	190.0	190.0
32	56.0			190.0
36	62.50			190.0
40	73.0			190.0

Protective Cap For 97B Series For Receptacles
97B-25043-XX-YY
XX-Shell Size
YY-Plating Finish
(Ref. Page 40 For Plating Finish)

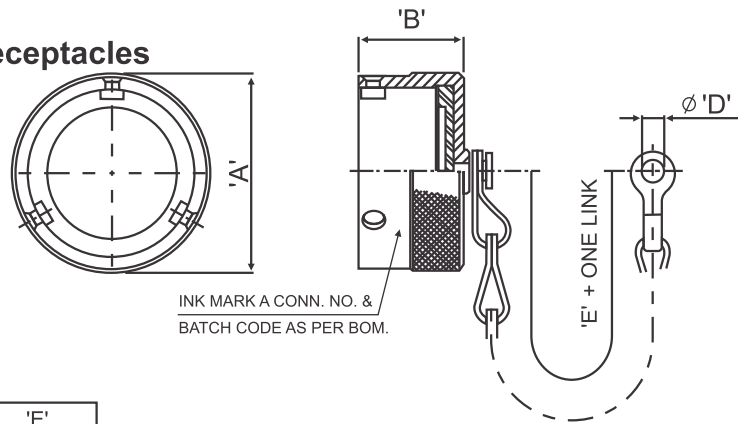

All dimensions are in mm

SHELL SIZE	'A' MAX.	'B' ± 0.20	'D' + 0.60/-0	'E' MIN.
10 SL	23.0	16.0	4.30	90.0
14 S	30.0			100.0
16 S	32.50	20.70	5.50	115.0
16				100.0
18	37.0			115.0
20	40.50			160.0
22	43.50	5.50	160.0	160.0
24	47.0			160.0
28	54.0	5.50	160.0	160.0
32	60.50			160.0
36	67.0			160.0
40	73.0			160.0

Note :- Please add 07 suffix for bigger end link. Applicable for Jam Nut

Dummy Receptacle Rear Side Closed

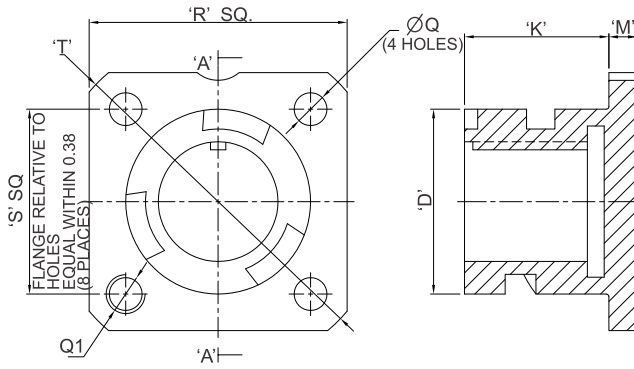

SHELL SIZE	oD +0.0 -0.13	'K' +0.38 -0.0	'M' +0.18	Q +0.10 -0.0	Q1	R +0.18 0.20	S +0.13	T +0.23 -0.25
10SL	18.19	14.20	2.79	3.23	M4	25.40	18.21	33.32
12S	21.30		3.20			28.05	20.60	36.20
14S	24.59					30.0	23.01	39.67
16S	27.38		19.0			3.99	32.51	24.61
16	27.38	3.73		35.05	27.0		46.02	
18	30.78			38.0	29.39		50.80	
20	34.16	40.99		31.80	53.98			
22	37.36	20.60	3.73	44.45	34.90	60.32		
24	40.87			4.32	50.80	39.70	66.68	
28	46.68				57.10	44.50	76.20	
32	53.36			63.50	49.20	84.12		
36	59.56	22.20						

Dummy Receptacle Rear Side Open (Hollow)

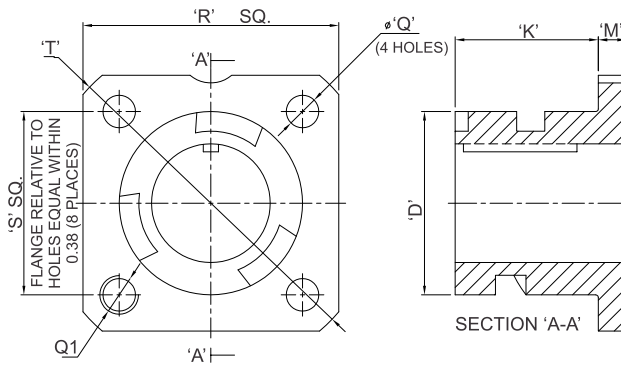

SHELL SIZE	oD +0.0 -0.13	'K' +0.38 -0.0	'M' +0.18	Q +0.10 -0.0	Q1	R +0.18 0.20	S +0.13	T +0.23 -0.25
10SL	18.19	14.20	2.79	3.23	M4	25.40	18.21	33.32
12S	21.30		3.20			28.05	20.60	36.20
14S	24.59					30.0	23.01	39.67
16S	27.38		19.0			3.99	32.51	24.61
16	27.38	3.73		35.05	27.0		46.02	
18	30.78			38.0	29.39		50.80	
20	34.16	40.99		31.80	53.98			
22	37.36	20.60	3.73	44.45	34.90	60.32		
24	40.87			4.32	50.80	39.70	66.68	
28	46.68				57.10	44.50	76.20	
32	53.36			63.50	49.20	84.12		
36	59.56	22.20						

ORDERING INFO

97B-3105-XX-CF

SERIES DESIGNATION

CF-CLOSED FLANGE
HF-HOLLOW FLANGE

DESIGNATION FOR
DUMMY RECEPTACLE

SHELL SIZE

Thru Bulkhead Receptacle

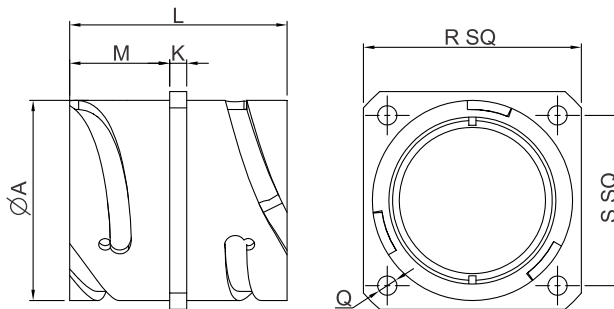

SHELL SIZE	'A' +0.0 -0.15	'K' +0.20	'M' +0.41 -0.0	'R' +0.10	'S' +0.20	'L' MAX.
10SL	18.21	2.79	14.20	18.20	25.40	37.75
12S	21.40	3.20	14.20	20.60	28.00	37.75
14S	24.61	3.20	14.20	23.00	30.00	37.75
16S	27.41	3.20	14.20	24.60	32.50	37.75
16	27.41	3.20	19.00	24.60	32.50	51.40
18	30.81	3.99	19.00	27.00	35.00	51.40
20	34.19	3.99	19.00	29.40	38.00	51.40
22	37.39	3.99	19.00	31.80	41.00	51.40
24	40.89	3.99	20.60	34.90	44.50	51.40
28	46.71	3.99	20.60	39.70	50.80	51.40
32	53.39	3.99	22.20	44.50	57.00	51.40
36	59.59	3.99	22.20	49.20	63.50	51.40

ORDERING INFO

TBH-97BS-XX-YY PS

THRU BULKHEAD SERIES

PIN & SOCKET CONTACT

SERIES DESIGNATION

INSERT ARRANGEMENT

Pin - Male Crimp Contact

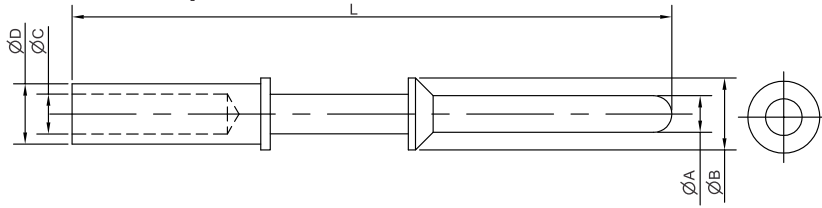

CONTACT PART NO	CONTACT SIZE	'A'	'B'	'C'	'D'	'L'
97B - 106433	16S	1.59	3.10	1.72	2.60	26.00
97B - 108295	16	1.59	3.10	1.72	2.60	30.50
97B - 108388	12	2.39	4.78	2.51	3.96	36.60
97B - 108386	8	3.60	7.85	4.57	6.75	40.70
97B - 108384	4	5.70	11.10	7.15	9.50	40.70
97B - 112067	0	9.05	15.00	11.90	13.90	44.45

Socket - Female Crimp Contact

Contact Size 12, 16, 16S

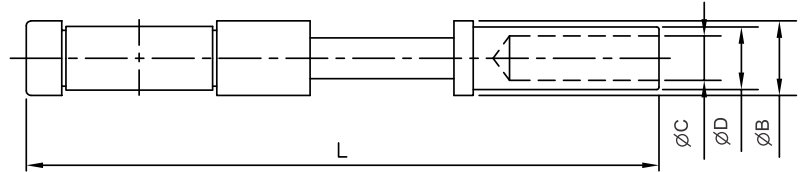

Contact Size 8

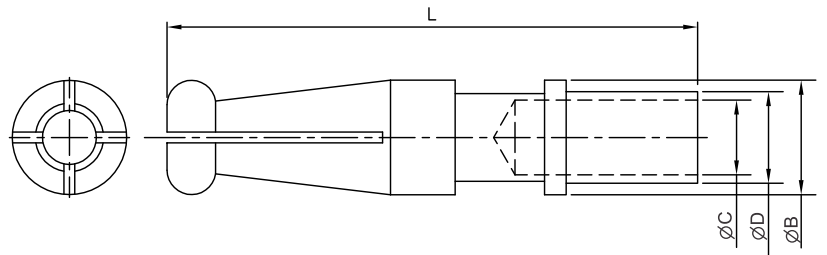

Contact Size 4

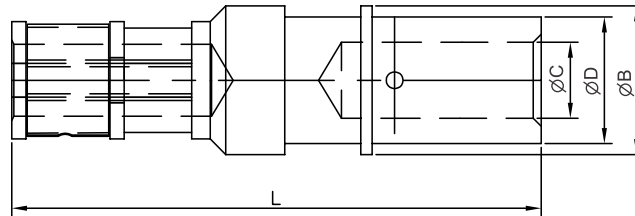

Contact Size 0

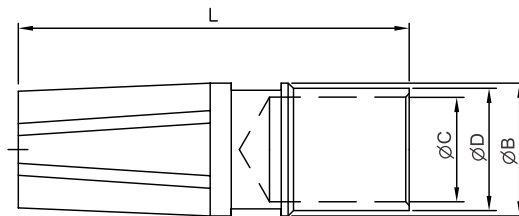

CONTACT PART NO	CONTACT SIZE	'B'	'C'	'D'	'L'
97B - 106433	16S	3.10	1.72	2.60	26.30
97B - 108295	16	3.10	1.72	2.60	34.20
97B - 109388	12	4.78	2.51	3.96	37.00
97B - 108386	8	7.85	4.57	6.75	37.00
97B - 108384	4	11.10	7.15	9.50	40.00
97B - 112067	0	15.00	11.90	13.90	44.45

97B Connector- Accessories

Crimp Contact

Contacts for 97B connectors are machined from copper alloys and silver plated for maximum corrosion resistance, with a minimum millivolt drop and a maximum current carrying capacity; the size 16 and 12 socket contacts are of the closed entry design. Gold plated contacts are also available.

Part Number For Crimp Contacts only*	Pin/Socket	Mating End Size	Wire Barrel Size	Allowable Wire size	Test Current*** Amps	Insertion/Removal Tool
97B-106433	Pin	16 Short†	16	16	13	97B-IR-16
97B-108456	Socket			18	10	
97B-108295	Pin	16 Long	16	60	7.5	97B-IR-16
97B-108457	Socket			22**	5	
97B-108388	Pin	12	12	16	13	97B-IR-12
97B-110262	Socket			18	10	
97B-108386	Pin	8	8	20	7.5	97B-IR-8
97B-108387	Socket			22**	5	
97B-108384	Pin	4	4	12	23	97B-IR-4
97B-111878	Socket			14	17	
97B-112067	Pin	0	0	8	46	97B-IR-0
97B-112068	Socket			10**	33	
				4	80	
				6**	60	
				0	150	
				1	125	
				2**		

* Solder contacts are not sold as separate items. Part numbers shown here are for crimp contacts only.

** When using wire adapter sleeve shown.

*** Contact rating as stated are test ratings only. The connector may not withstand full rated current through all contacts continuously. Please note that the electrical data given is not an establishment of electrical safety factors. This is left entirely in the designer's hands as he can best determine which peak voltage, switching surges, transients, etc. can be expected in a particular circuit.

MS/97B Connectors Application Tools

When proprietary crimp contacts are employed rather than the standard 97B approved solder contacts, the following application tools are recommended for use. There is a possibility of additional crimping tools other than those included being available at present or in the future for this specific application.

TOOLING CHART

Contact Size	Crimping Tool	Positioner/Turret
16S	M22520/1-01	M22520/1-02
16	M22520/1-01	M22520/1-02
12	M22520/23-01	M22520/1-02
8	M22520/23-01	M22520/23-02
4	M22520/23-01	M22520/23-02
0	M22520/23-01	M22520/23-02

To obtain the specific connector required, write down the connector number from the typical example below. Only inserts shown in the availability chart shown on page 7 can be specified. Connectors are delivered with protective plastic dust covers. Include pre-mating contact designation only if pre-mating contact is required. The second letter in the pre-mating contact designation stands for the actual contact position. **B** at the end of the connector number indicates telescopic bushing provided.

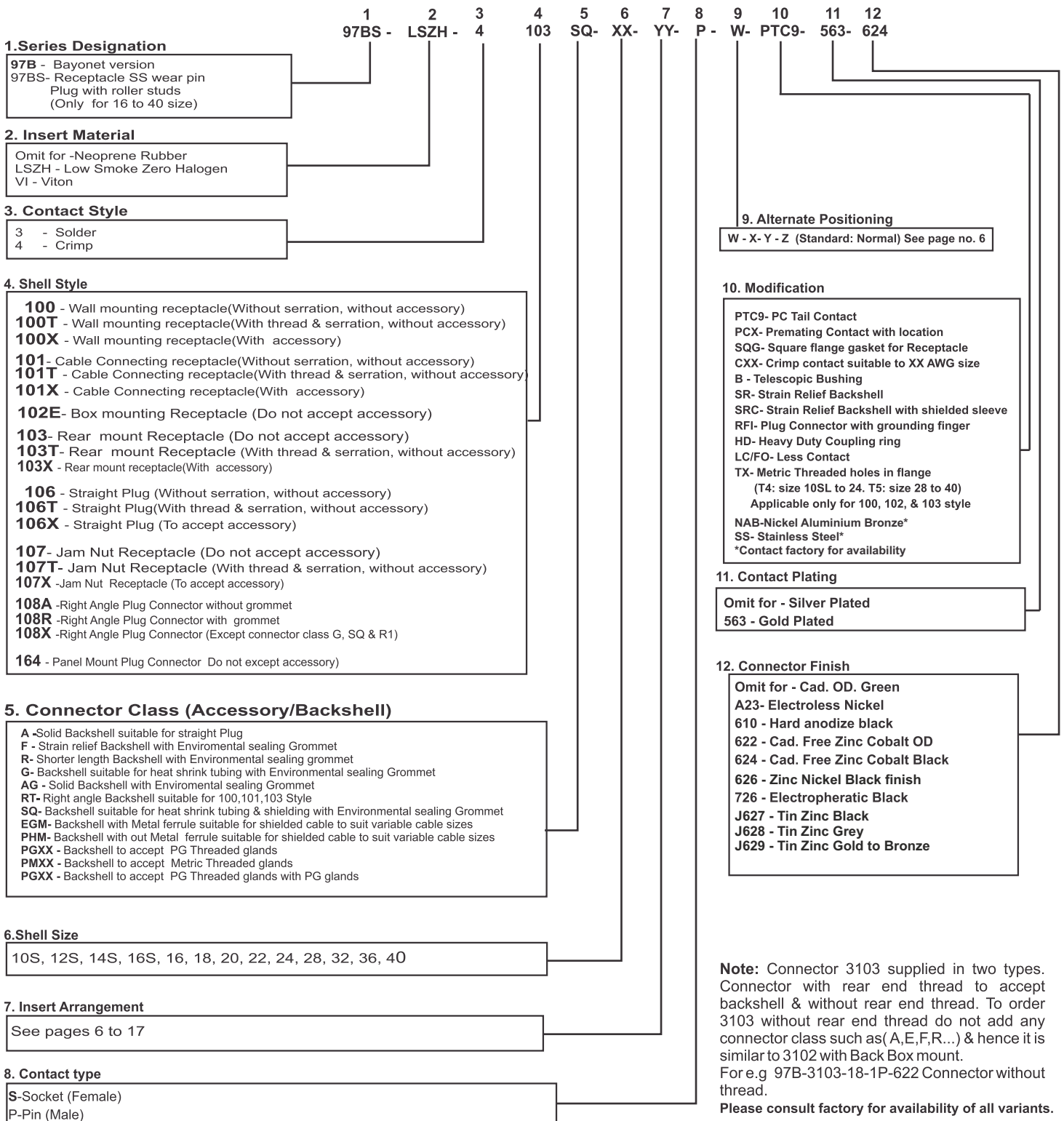

Note: Connector 3103 supplied in two types. Connector with rear end thread to accept backshell & without rear end thread. To order 3103 without rear end thread do not add any connector class such as(A,E,F,R...) & hence it is similar to 3102 with Back Box mount. For e.g 97B-3103-18-1P-622 Connector without thread.
Please consult factory for availability of all variants.

Notice : All information, including illustrations given herein is believed to be accurate at the time of printing. In lieu of design advances, Amphenol reserves the right to change specifications without notice. This publication ACRMS02 06/18 97B Series Connectors supercedes all existing Amphenol literature on 97 B Series Connectors.

NORTH AMERICA

Sales & Product Support

Amphenol PCD
72 Cherry Hill Drive
Beverly, MA 01915 USA
Tel: +1-978-624-3400
Fax: +1-978-927-1513
info@amphenolpcd.com
www.amphenolpcd.com
www.backshellworld.com

Amphenol Aerospace Operations
40-60, Delaware Avenue
Sidney, NY 13838-1395
Tel: +1-607-563-5011
Fax: +1-607-563-5357

Amphenol Canada
Meford Drive
Scarborough,
ON M1B 2X6
Tel: +416-291-4401
Fax: +416-292-0647

Amphenol Fiber Systems International
1300 Central Expressway North
Suite 100 Allen, Texas 75013, USA
Tel: +1-214-547-2400
Fax: +1-214-547-9344

EUROPE

France

Amphenol Socapex S.A.S.
948, Promenade de l'Arve
Bp29, Thyez Cedex
74311, France
Tel: +33-4-5089-2800
Fax: +33-4-5096-1941

United Kingdom

Amphenol Limited
Thanet Way, Whitstable
Kent CT5 3JF, England
Tel: +44-1227-773-200
Fax: 44-1227-276-571

Germany

Amphenol-Air LB GmbH
Am Kleinbahnhof 4
Saarlouis
D-66740, Germany
Tel: 49-6831-9810-00
Fax: 49-6831-9810-30

Italy

Amphenol Military &
Aerospace Operations-
European Sales Operations
Via Barbaiana 5
20020 Lainate
Milano,
Italy+39 02 932 541

Center & East Europe

Amphenol Austria
Wiener Gasse 68
2380 Perchtoldsdorf
Tel: +43-699-10396071
Fax: +43 699 40396071

Amphenol Air-LB
Immeuble Le Doublon
11, Avenue Dobonnet
Courbevoie-Cedex
92407, France
Ph: +33-1-4905-3000
Fax: +33-1-4905-3043

Spain

Amphenol Iberica
Edificio Burgosol Oficina
N 55 C/Comunidad de
Madrid 35 bis -
Las Rozas (Madrid)
Tel: +34-91-6407302
+34-91-6407306
Fax: +34-91-6407307

Holland

Amphenol Benelux
Zadelmaker 121
NL-2401 PD Alphen
aan den Rijn Holland
Tel: +31-172-444903
Fax: +31-172 240254

Sweden

Amphenol
Industrial and Military &
Aerospace
Nordic & Baltic
Military Phone/
Mobile+46702129200
Industrial +46 767909560

ASIA

India

Amphenol Interconnect India Pvt. Ltd.
105 Bhosari Industrial Area
Pune-411026, India
Tel: +9120-6736-0373
Fax: +9120-2712-9158

Amphenol Interconnect India Pvt. Ltd.
61 Electronics City
Bangalore-560 100, India
Ph: +9180-2852-3838
Fax: +9180-2852-0418

Japan

Amphenol Japan
471-1, Deba, Ritto City
Shiga 520-3041, Japan
Tel: +81-77-553-8501
Fax: +81-77-551-2200

Korea

Amphenol Daeshin Electronics
558 SoSa, SongNae, Bucheon-City
Kyunggi-Do, Korea 420-130
Tel: +82-32-610-3800
Fax: +92-32-673-2507

Singapore

Amphenol East Asia Ltd.
72 Bendemeer Road
03-33 Luzerne
Singapore 339 941
Tel: 65-6294-2128
Fax: 65-6294-3522

China

Amphenol PCD Shenzhen
3/F Building, A4 Songbai
Industrial Park
East Road of Minghuan
Gongming Town, Baon District
Shenzhen, China
Tel: +86-755-8173-8000
Fax: +86-755-8173-8180

ROW

Australia

Amphenol Australia Pty Ltd
2 Fiveways Boulevard
Keysborough
VIC 3173
Ph: +61-3-8796-8888
Fax: +61-3-8796-8801

Africa

Amphenol South Africa
30 Impala Road
2196 Sandton-Chistlehurst
South Africa
Tel: +27-11-783-9517
Fax: +27-11-783-9519

Russia

Amphenol Russia
8-2 Yaroslavskaja Str
129164 Moscow, Russia
Tel: +7-495-937-6341
Fax: +7-495-937-6319

Argentina

Amphenol Argentina
Avenida Callao 930
2nd Floor, Office B Plaza
C1023AAP Buenos Aires
Argentina
Tel: 54-11-4815-6886
Fax: 54-11-4814-5779

Israel

Amphenol Bar-Tec Ltd.
www.bar-tec.com
3 Hagavish st
POB 2479 Kfar-Saba 44641
Israel+972-9-7644100

Turkey

Amphenol Turkey & Middle East
Sun Plaza Kat:19
Maslak Mah. Bilim Sok.No:5
34398 Sisli - Istanbul
Tel: +90-212-335-2501
Fax: +90-212-335-2500

Brazil

Amphenol do Brasil Ltda
Rua Diogo Moreira 132
CEP 05423-010
Sao Paulo-SP, Brazil
Tel: +55-11-3815-1003
Fax: +55-11-3815-1629

Amphenol

A Global Company



Pune Operations



Bangalore Operations

Amphenol

Interconnect India Pvt. Ltd.

Manufacturing Locations

Corporate Office & Pune Factory
105, Bhosari Industrial Area, Pune - 411 026.
Tel.: 91-20-6736 0305 / 304
Fax : 91-20-6736 0321

Bangalore Factory
61, Keonics Electronic City, Hosur Road,
Bangalore - 560 100.
Tel.: 91-80-6679 0900 / 910 / 937
Fax.: 91-80-2852 0418
Email : apurvac@amphenol-in.com

Marketing Headquarters
Tel.: 91-20-6736 0305, 6736 0304
Fax : 91-20-6736 0321
Email : svpatil@amphenol-in.com

Western Region
Tel.: 91-20-6736 0334 / 395
Email : sunilp@amphenol-in.com

Northern & Eastern Region
A-421, Pacific Business Park,
Plot No. 37/1, Sahibabad Indst. Area
Site IV, Ghaziabad (UP) - 201 010.
Tel.: 91-120- 4155 781 / 782
Email : sunily@amphenol-in.com

Marketing Locations

Southern Region
No. 1115, 22nd Main Road, 11th Cross,
Sector -1, HSR Layout, Bangalore - 560 102.
Tel.: 91-80-4953 0341 / 345 / 346
Fax: 91-80-4953 8697
Email : kmanoj@amphenol-in.com

Central Region
9/17/A&B, 4th Floor, West Block,
Pinnacle Towers, Road No. 6, IDA Nacharam,
Hyderabad - 500076
Tel.: 91-40-2930 2810
Fax.: 91-40-2930 2811
Email : pprasad@amphenol-in.com

Exports
Tel.: 91-20-6736 0371 / 353
Fax: 91-20-6736 0321
Email : shrikantgramopadhye@amphenol-in.com

www.amphenol-in.com