

Amphenol

ACAMS02 04 18

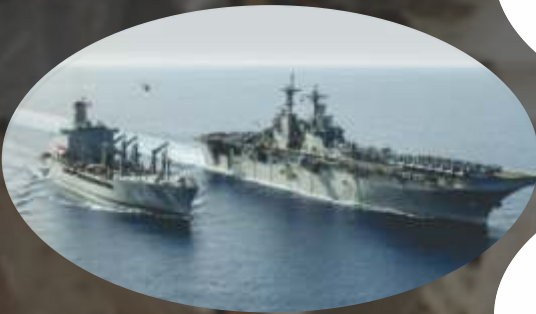

Amphenol

Introduction

Amphenol MS series connectors are threaded coupling mechanism connectors designed to meet operating requirements of MIL-C-5015 specification. These connector are designed considering the various Industrial applications needs. But due to its features such as low cost environmental sealed connectors they are used in other applications such as Automotive, Mass transportation, Entertainment and Geophysical.

These connectors have various combination of power and signal contacts from 1-85 numbers, which allows current capacity from 13A to 150A per contact.

Content	Page
Introduction	1
Connector Style	2
General Description	3
Electrical Data	4
Insert Orientations	5
Insert Arrangements	6-17
Shell Style	18-20
3106A/4106A	21
3108F/4108F	22
MS3057-A Style	23
MS25042	24
MS25043	25
Back Accessory	26
Connector Accessory	27
Ordering information	28

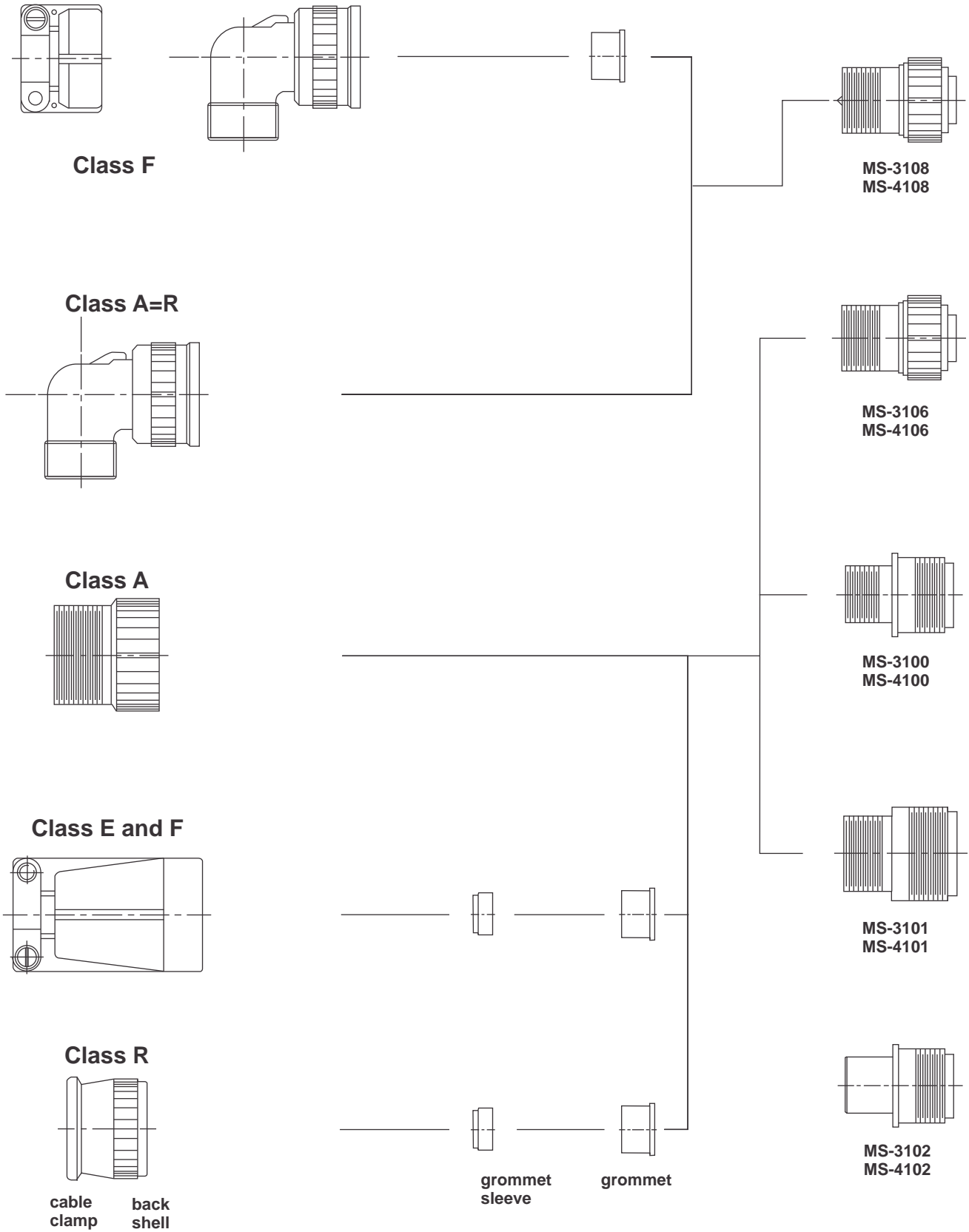

These electrical connectors are designated MS because the interchangeability and operating characteristics are determined by U.S. Military Specifications. These specifications are revised from time to time to incorporate performance requirements dictated by design advances and more stringent requirements of allied equipment. The several designations of MS and 97B connectors meet different requirements of MIL-C-5015. These designations and general descriptions are as follows :

Shell

Shell constructions include solid back shell (A) and environmental resistant (E, F & R). Environmental resistant connectors provide a moisture barrier and assure a positive seal. Shell styles consist of wall type receptacles (3100), cable receptacles (3101), box receptacles (3102), straight plugs (3106) and angle plugs (3108). Shell hardware is manufactured from aluminium alloy and cadmium plated with olive drab chromate finish. This finish has excellent conductivity; it is non-reflecting and corrosion resistant. Black anodised finish and cadmium-free zinc plating with olive drab chromate finish are also available. For details, contact factory.

Contacts

Pin and socket contacts are of brass and generally silver plated. Gold plating is also available. For details contact factory. These contacts are available for solder or crimp termination. Special arrangements of contacts for pre-mating and pre-earth are also available.

Inserts and grommet

Synthetic inserts and grommet manufactured according to MIL-R-3065, offer high dielectric strength and are resistant to oils, gasoline and low temperature. DAP is dimensionally stable, has high arc resistance and high insulation resistance under both humidity and thermal stress.

General description

Plugs are available in A, F and R types. Receptacles are available in A, E, F and R types.

A Solid back shell

Intended for general service usage to provide convenient means of connecting and disconnecting electrical circuits in industrial and military applications.

Environmental resisting

Intended for use where the connector will be subject to heavy condensation and rapid changes in temperature or pressure and/or where the connector is subjected to high vibratory conditions.

E Environmental resisting with grommet seal and strain relief backshell except for 3102 type.

F Environmental resisting with grommet seal, strain relief backshell and front gasket seal for plug type.

R Environmental resisting with grommet seal, shorter and lightweight.

Dielectric Strength

Service rating	Test Voltage Vac rms
Inst.	1000V
A	2000V
D	2800V
E	3500V
B	4500V
C	7000V

Contact rating

Contact Size	Rated Current	Contact Resistance miliohms
16	13A	3.46
12	23A	1.83
8	46A	0.52
4	80A	0.26
0	150A	0.14

Service rating

Service rating	Operating Voltage DC at Sea Level	Operating Voltage AC at Sea Level
Inst.	250V	200V
A	700V	500V
D	1250V	900V
E	1750V	1250V
B	2450V	1750V
C	4200V	3000V

Insert Orientation

To avoid cross-plugging problems in applications requiring the use of more than one connector of the same size and arrangement, alternate insert rotations are available as indicated in the accompanying chart.

As shown in the diagram below, the front face of the pin insert is rotated within the shell in a clockwise direction from the normal shell key. The socket insert would be rotated counterclockwise the same number of degrees with respect to the normal shell key.

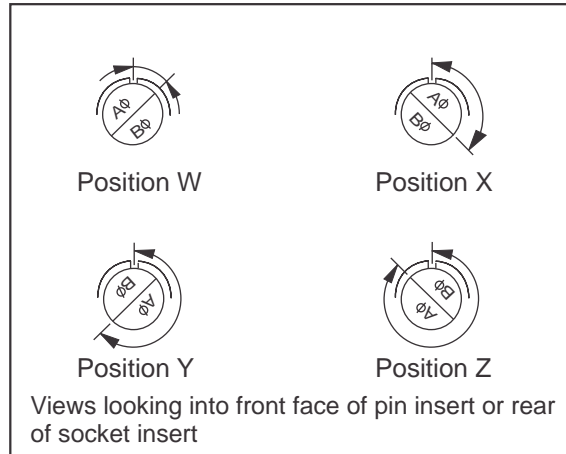

The following insert arrangements have the same alternate insert rotations for W, X, Y and Z which are as below :

Degree			
W	X	Y	Z
80	110	250	280

16-7	20-16	22-18	24-6	28-8	32-1
18-5	20-20	22-19	24-7	28-9	32-3
18-9	20-22	22-21	24-12	28-10	32-4
18-13	22-3	22-24	24-16	28-11	32-6
18-14	22-6	22-25	24-17	28-15	36-1
20-7	22-12	22-29	24-20	28-16	36-7
20-8	22-14	22-34	24-21	28-17	36-8
20-9	22-15	24-3	24-28	28-19	36-13
20-12	22-16	24-4	28-1	28-20	
20-14	22-17	24-5	28-4	28-21	

Insert Arrangement	Degrees			
	W	X	Y	Z
12S-3	70	145	215	290
14S-2	-	120	240	-
14S-5	-	110	-	-
14S-7	90	180	270	-
14S-9	70	145	215	290
16-9	35	110	250	325
16-10	90	180	270	-
16-11	35	110	250	325
16-13	35	110	250	325
16S-1	80	-	-	280
16S-4	35	110	250	325
16S-5	70	145	215	290
16S-6	90	180	270	-
16S-8	-	170	265	-
18-1	70	145	215	290
18-3	35	110	250	325
18-4	35	110	250	325
18-8	70	-	-	290
18-10	-	120	240	-
18-11	-	170	265	-
18-12	80	-	-	280
18-15	-	120	240	-
18-20	90	180	270	-
18-19	-	120	240	-
18-22	70	145	215	290
18-29	90	180	270	-
20-3	70	145	215	290
20-4	45	110	250	-

Insert Arrangement	Degrees			
	W	X	Y	Z
20-6	70	145	215	290
20-15	80	-	-	280
20-17	90	180	270	-
20-18	35	110	250	325
20-19	90	180	270	-
20-21	35	110	250	325
20-23	35	110	250	325
20-24	35	110	250	325
20-27	35	110	250	325
20-29	80	-	-	280
22-1	35	110	250	325
22-2	70	145	215	290
22-4	35	110	250	325
22-5	35	110	250	325
22-8	35	110	250	325
22-9	70	145	215	290
22-10	35	110	250	325
22-11	35	110	250	325
22-13	35	110	250	325
22-20	35	110	250	325
22-22	-	110	250	-
22-23	35	-	250	-
22-27	80	-	250	280
22-28	80	-	-	280
24-2	80	-	-	280
24-9	35	110	250	325
24-10	80	-	-	280
24-11	35	110	250	325

Insert Arrangement	Degrees			
	W	X	Y	Z
24-22	45	110	250	-
24-27	80	-	-	280
28-2	35	110	250	325
28-3	70	145	215	290
28-5	35	110	250	325
28-6	70	145	215	290
28-7	35	110	250	325
28-12	90	180	270	-
28-18	70	145	215	290
28-22	70	145	215	290
32-7	80	125	235	280
32-8	80	125	235	280
36-3	70	145	215	290
36-4	70	145	215	290
36-5	-	120	240	-
36-6	35	110	250	325
36-9	80	125	235	280
36-10	80	125	235	280
36-14	90	180	270	-
36-15	60	125	245	305
40-56	72	144	216	288
36-52	72	216	235	258
32-5	35	110	250	325
32-17	45	110	250	-
40-56	72	144	216	288

Insert Arrangements

Insert Arrangement	Service Rating	Total Cont-acts	Contact Size				
			0	4	8	12	16
10S-2	A	1					1
10SL-3	A	3					3
10SL-4	A	2					2
12S-3	A	2					2
12S-4	D	1					1
12-5	D	1				1	
14S-1	A	3					3
14S-2	Inst	4					4
14S-4	D	1					1
14S-5	Inst	5					5
14S-6	Inst	6					6
14S-7	A	3					3
14S-9	A	2					2
14S-10	Inst	4					4
14S-12	A	3					3
14-3	A	1			1		
14S-A7	A	19	19				
16S-1	A	7					7
16S-3	B	1					1
16S-4	D	2					2
16S-5	A	3					3
16S-6	A	3					3
16S-8	A	5					5
16-2	E	1				1	
16-7	A	3			1		2
16-9	A	4				2	2
16-10	A	3				3	
16-11	A	2				2	
16-12	A	1		1			
16-13	A	2				2	
18-1	A/Inst	10					10
18-3	D	2				2	
18-4	D	4					4
18-5	D	3				2	1
18-06		6				4	2
18-6	D	1		1			
18-7	B	1			1		
18-8	A	8				1	7
18-9	Inst	7				2	5
18-10	A	4				4	
18-11	A	5				5	
18-12	A	6					6
18-13	A	4			1	3	
18-14	A	2		1			1
18-15	A	4				4	
18-16	C	1				1	
18-17	Inst	7				2	5
18-19	A	10					10
18-20	A	5					5
18-22	D	3					3
18-24	A/Inst	10					10
18-29	A	5					5
18-30	A	5					5
18-31	A	5					5
20-2	D	1	1				
20-3	D	3				3	
20-4	D	4				4	
20-6	D	3					3
20-7	D/A	8					8

Insert Arrangement	Service Rating	Total Cont-acts	Contact Size				
			0	4	8	12	16
20-8	Inst	6			2		4
20-9	D/A	8				1	7
20-11	Inst	13					13
20-12	A	2		1			1
20-14	A	5			2	3	
20-15	A	7				7	
20-16	A	9				2	7
20-17	A	6				5	1
20-18	A	9				3	6
20-19	A	3			3		
20-20	A	4		1		3	
20-21	A	9				1	8
20-22	A	6			3		3
20-23	A	2			2		
20-24	A	4			2		2
20-25	Inst	13					13
20-27	A	14					14
20-29	A	17					17
20-30	Inst	13					13
20-33	A	11					11
20-A48	A	19					
22-1	D	2			2		
22-2	D	3			3		
22-4	A	4			2	2	
22-5	D	6				2	4
22-6	D	3			2		1
22-7	E	1	1				
22-8	E	2				2	
22-9	E	3				3	
22-10	E	4					4
22-11	B	2					2
22-12	D	5			2	3	
22-13	D/A	5				4	1
22-14	A	19					19
22-15	E/A	6				5	1
22-16	A	9				3	6
22-17	D/A	9				1	8
22-18	D/A	8					8
22-19	A	14					14
22-20	A	9					9
22-21	A	3	1				2
22-22	A	4			4		
22-23	D/A	8				8	
22-24	D/A	6				2	4
22-27	D/A	9			1		8
22-28	A	7				7	
22-34	D	5				3	2
24-2	D	7				7	
24-3	D	7				2	5
24-4	D	4	1				3
24-5	A	16					16
24-6	D/A	8				8	
24-06	A	6		4			2
24-7	A	16				2	14
24-9	A	2		2			
24-10	A	7			7		

Insert Arrangement	Service Rating	Total Cont-acts	Contact Size				
			0	4	8	12	16
24-11	A	9			2	3	
24-12	A	5		2		3	
24-16	D/A	7			1	3	3
24-17	D	5				2	3
24-20	D	11				2	9
24-21	D	10			1		9
24-22	D	4			4		
24-27	E	7					7
24-28	Inst	24					24
28-1	D/A	9			3	6	
28-2	D	14				2	12
28-3	E	3			3		
28-4	E/D	9				2	7
28-5	D	5		2		1	2
28-6	D	3		3			
28-7	D	2		2			
28-8	E/D/A	12				2	10
28-9	D	12				6	6
28-09	A	9		4			5
28-10	D/A	7		2	2	3	
28-11	A	22				4	18
28-12	A	26					26
28-13	A	26					26
28-15	A	35					35
28-16	A	20					20
28-17	B/D/A	15					15
28-18	C/D/A/Inst	12					12
28-19	B/D/A	10				4	6
28-20	A	14				10	4
28-21	A	37					37
28-22	D	6		3			3
28-51	D	12					12
32-1	D/A	5	2			3	
32-3	D	9	1	2		2	4
32-4	D/A/D	14				2	12
32-5	D	2	2				3
32-6	A	23		2	3	2	16
32-7	INSTA	35				7	28
32-8	A	30				6	24
32B-13	D	13			13		
32-17	D	4		4			
32-22	A	54					54
36-1	D	22				4	18
36-3	D	6	3			3	
36-4	D/A	3	3				
36-5	A	4	4				
36-6	A	6	2	4			
36-7	A	47				7	40
36-8	A	47				1	46
36-9	A	31		1	2	14	14
36-10	A	48					48
36-11	A	48					48
36-12	A	48					48
36-13	E/A	17				2	15
36-14	D	16			5	5	6
36-15	D/A	35					35
36-16	A	47				7	40
36-17	A	47				7	40
36-18	A	31		1	2	14	14
36-20	A	34			2	2	30
36-46	A	27					27
36-52	A	52					52
40-56	A	85					85
40-63	A	61					

Insert Arrangements

Front face of pin insert or rear of socket insert illustrated

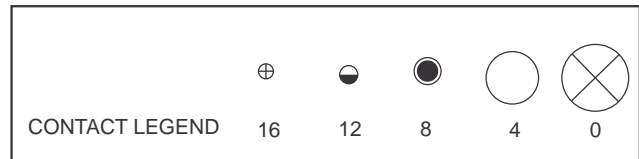

		Front of socket insert	Front of socket insert			
Insert arrangement	10S-2	10SL-3	10SL-4	12S-3	12S-4	12-5
Service rating	A	A	A	A	A	D
Number of contacts	1	3	2	2	1	1
Contact size	16	16	16	16	16	12
Premating contact	-	C	-	-	-	-



Insert arrangement	14S-A7	14S-1	14S-2	14S-4	14S-5	14S-6
Service rating	A	A	Inst.	D	Inst.	Inst.
Number of contacts	7	3	4	1	5	6
Contact size	16	16	16	16	16	16
Premating contact	-	-	-	-	-	-



			100° rotation of 14S-2	100° rotation of 14S-7		
Insert arrangement	14S-7	14S-9	*14S-10	*14S-12	*14-3	16S-1
Service rating	A	A	Inst.	A	A	A
Number of contacts	3	2	4	3	1	7
Contact size	16	16	16	16	8	16
Premating contact	B	-	-	B	-	G



Insert arrangement	*16S-3	16S-4	16S-5	16S-6	16S-8	*16-2
Service rating	B	D	A	A	A	E
Number of contacts	1	2	3	3	5	1
Contact size	16	16	16	16	16	12
Premating contact	-	-	A	B	E	-

*Not tooled up, can be tooled up on request. Contact Factory.

Insert Arrangements

Front face of pin insert or rear of socket insert illustrated

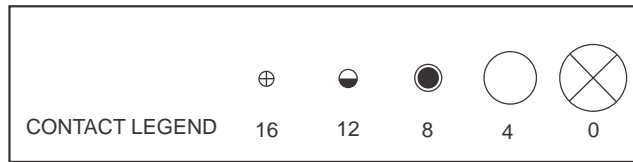

Insert arrangement	16-7	16-9	16-10	16-11	16-12	*16-13
Service rating	A	A	A	A	A	A
Number of contacts	1 2	2 2	3	2	1	2
Contact size	8 16	12 16	12	12	4	12
Premating contact	C	-	B	-	-	-

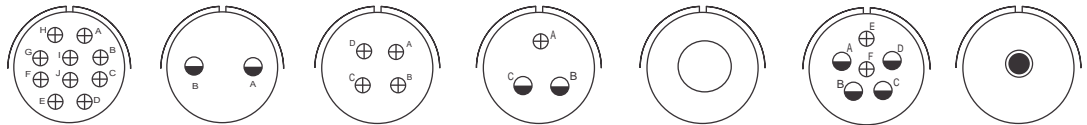

Insert arrangement	18-1	18-3	18-4	18-5	*18-6	18-06	18-7
Service rating	B,C,F,G=A; Bal.=Inst.	D	D	D	D	A	B
Number of contacts	10	2	4	2 1	1	2 4	1
Contact size	16	12	16	12 16	4	16 12	8
Premating contact	-	-	A	C	-	-	-



Insert arrangement	18-8	18-9	18-10	18-11	18-12	*18-13
Service rating	A	Inst.	A	A	A	A
Number of contacts	1 7	2 5	4	5	6	1 3
Contact size	12 16	12 16	12	12	16	8 12
Premating contact	H	-	D	E	C or D	A

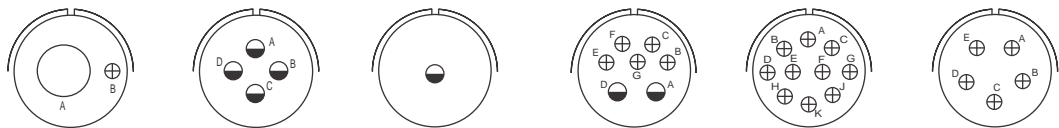

Insert arrangement	*18-14	18-15	18-16	*18-17	18-19	18-20
Service rating	A	A	C	Inst.	A	A
Number of contacts	1 1	4	1	2 5	10	5
Contact size	4 16	12	12	12 16	16	16
Premating contact	-	-	-	-	K	D

100° rotation of 18-9

*Not tooled up, can be tooled up on request. Contact Factory.

Insert Arrangements

Front face of pin insert or rear of socket insert illustrated

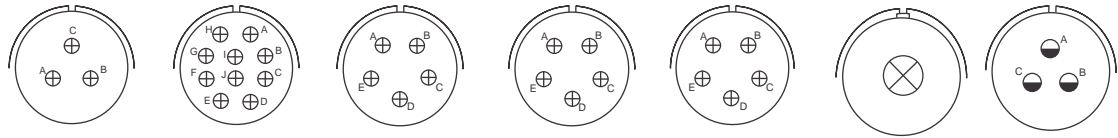
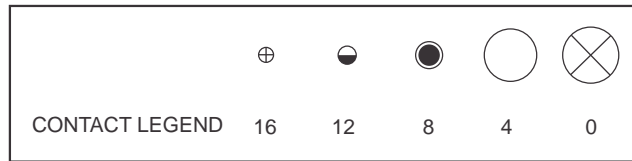

		250° rotation of 18-1		110° rotation of 18-20	260° rotation of 18-20		
Insert arrangement	18-22	*18-24	*18-29	*18-30	*18-31	20-2	20-3
Service rating	D	B,C,F,G=A; Bal.=Inst.	A	A	A	D	D
Number of contacts	3	10	5	5	5	1	4
Contact size	16	16	16	16	16	0	12
Premating contact	C	-	D	C	C	-	A



Insert arrangement	20-4	*20-6	20-7	20-8	20-9	20A-9
Service rating	D	D	A,B,H,G=D; C,D,E,F=A	Inst.	H=D; Bal.=A	A
Number of contacts	4	3	8	2 4	1 7	9
Contact size	12	16	16	8 16	12 16	12
Premating contact	C or D	A	A	-	H	-

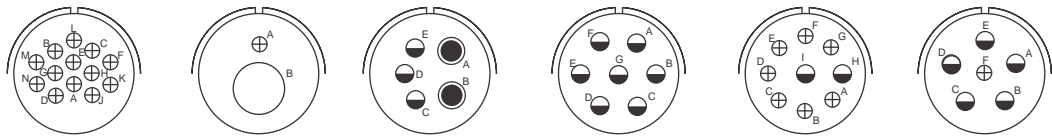

Insert arrangement	20-11	*20-12	20-14	20-15	20-16	20-17
Service rating	Inst.	A	A	A	A	A
Number of contacts	13	1 1	2 3	7	2 7	5 1
Contact size	16	4 16	8 12	12	12 16	12 16
Premating contact	-	-	D	A or D	E	E or F

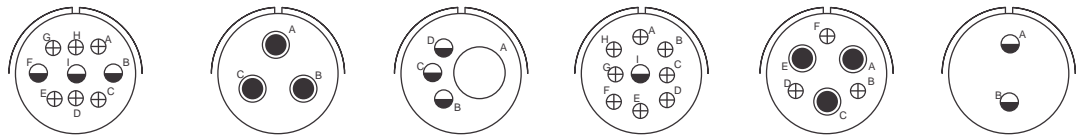

Insert arrangement	20-18	20-19	20-20	*20-21	20-22	20-23
Service rating	A	A	A	A	A	A
Number of contacts	3 6	3	1 3	1 8	3 3	2
Contact size	12 16	8	4 12	12 16	8 16	8
Premating contact	D	C	A	1	-	-

*Not tooled up, can be tooled up on request. Contact Factory.

Insert Arrangements

Front face of pin insert or rear of socket insert illustrated



		100° rotation of 20-11			250° rotation of 20-11
Insert arrangement	20-24	*20-25	20-27	20-29	*20-30
Service rating	A	Inst.	A	A	Inst.
Number of contacts	2 2	13	14	17	13
Contact size	8 16	16	16	16	16
Premating contact	-	-	M	G	-
Insert arrangement	20-33	20 A - 48	22-1	22-2	*22-4
Service rating	A	A	D	D	A
Number of contacts	11	19	2	3	2 2
Contact size	16	16	8	8	8 12
Premating contact	E	-	-	A	C
Insert arrangement	22-5	*22-6	22-7	*22-8	22-9
Service rating	D	D	E	E	E
Number of contacts	2 4	2 1	1	2	3
Contact size	12 16	8 16	0	12	12
Premating contact	D	B	-	-	A
Insert arrangement	22-10	22-11	22-12	22-13	22-14
Service rating	E	B	D	E=D; A, B, C, D=A	A
Number of contacts	4	2	2 3	4 1	19
Contact size	16	16	8 16	12 16	16
Premating contact	C	-	A	E	A

*Not tooled up, can be tooled up on request. Contact Factory.

Insert Arrangements

Front face of pin insert or rear of socket insert illustrated

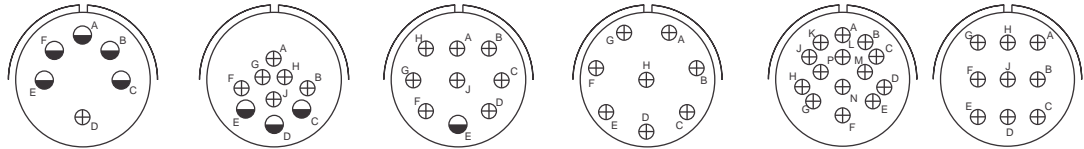
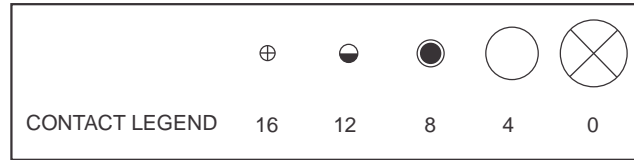

Insert arrangement	22-15	22-16	*22-17	22-18	22-19	22-20
Service rating	D=E;A,B,C,E,F=A	A	A=D;Bal.=A	A,B,F,G,H=D;C,D,E=A	A	A
Number of contacts	5 1	3 6	1 8	8	14	9
Contact size	12 16	12 16	12 16	16	16	16
Premating contact	D	D	E	D	F	D

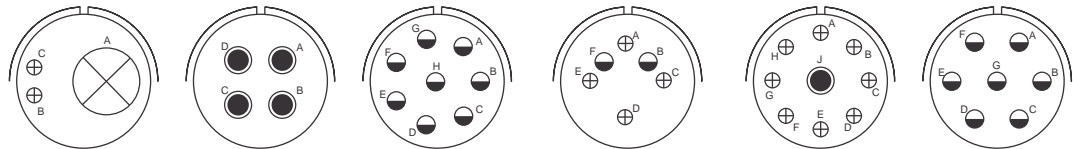

Insert arrangement	*22-21	22-22	22-23	22-24	22-27	22-28
Service rating	A	A	H=D;Bal.=A	C,D,E=D;A,B,F=A	J=D;Bal.=A	A
Number of contacts	1 2	4	8	2 4	1 8	7
Contact size	0 16	8	12	12 16	8 16	12
Premating contact	-	C or D	A or D	D	-	G

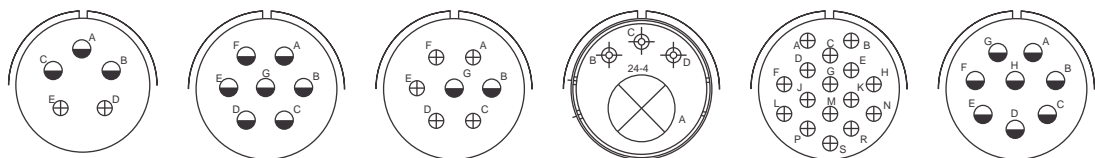

Insert arrangement	*22-34	24-2	*24-3	24-4	24-5	24-6
Service rating	D	D	D	A	A	A,G,H=D;Bal.=A
Number of contacts	3 2	7	2 5	3 1	16	8
Contact size	12 16	12	12 16	16 0	16	12
Premating contact	E	A	D	-	S	D

*Not tooled up, can be tooled up on request. Contact Factory.

Insert Arrangements

Front face of pin insert or rear of socket insert illustrated

CONTACT LEGEND	16	12	8	4	0

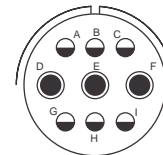
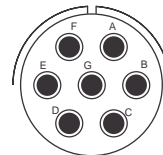
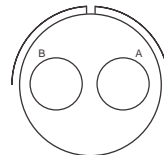
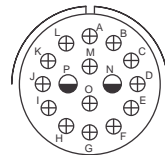
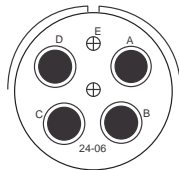

Insert arrangement
Service rating
Number of contacts
Contact size
Premating contact

24-06
A
2 4
16 8
-

24-7
A
2 14
12 16
G

24-9
A
2
4
-

24-10
A
7
8
D or E or G

24-11
A
3 6
8 12
E

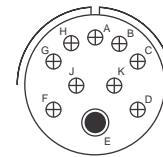
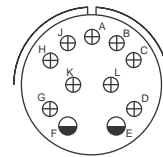
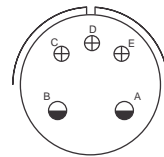
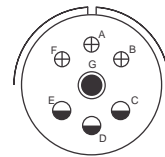
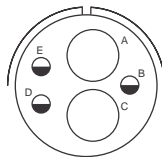

Insert arrangement
Service rating
Number of contacts
Contact size
Premating contact

24-12
A
2 3
4 12
-

*24-16
A,B,F,G=D; C,D,E=A
1 3 3
8 12 16
G

*24-17
D
2 3
12 16
D

24-20
D
2 9
12 16
A

24-21
D
1 9
8 16
E

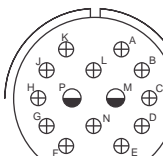
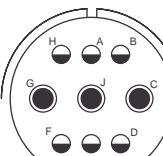
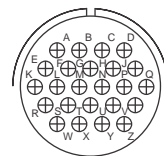
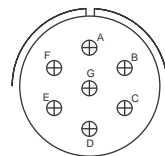
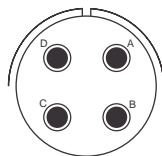

Insert arrangement
Service rating
Number of contacts
Contact size
Premating contact

24-22
D
4
8
D

*24-27
E
7
16
D

24-28
Inst.
24
16
-

28-1
A,J,E=D; Bal.=A
3 6
8 12
E

*28-2
D
2 12
12 16
E

*Not tooled up, can be tooled up on request. Contact Factory.

Front face of pin insert or rear of socket insert illustrated

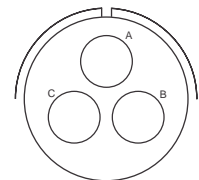
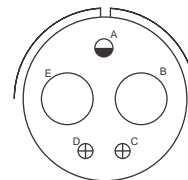
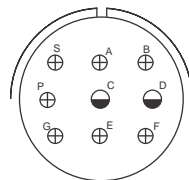
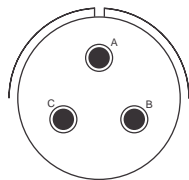
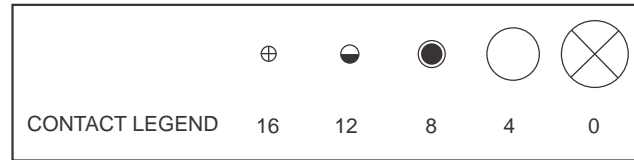

Insert arrangement
Service rating
Number of contacts
Contact size
Premating contact

28-3
E
3
8
A

*28-4
G,S,P=E;Bal.=D
2 7
12 16
E

*28-5
D
2 1 2
4 12 16
-

28-6
D
3
4
A

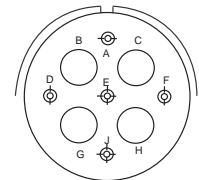
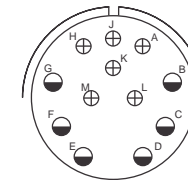
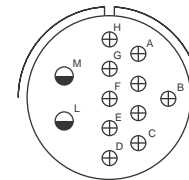
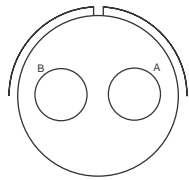

Insert arrangement
Service rating
Number of contacts
Contact size
Premating contact

28-7
D
2
4
-

28-8
L,M=E;B=D;Bal.=A
2 10
12 16
D

28-9
D
6 6
12 16
E

28-09
A
5 4
16 4
-

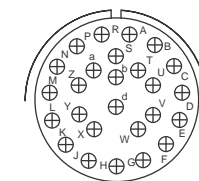
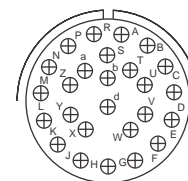
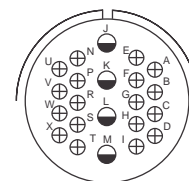
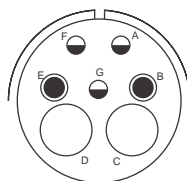

Insert arrangement
Service rating
Number of contacts
Contact size
Premating contact

28-10
G=D;Bal.=A
2 2 3
4 8 12
G

28-11
A
4 18
12 16
M

28-12
A
26
16
H

*28-13
A
26
16
H

*Not tooled up, can be tooled up on request. Contact Factory.

Insert Arrangements

Front face of pin insert or rear of socket insert illustrated

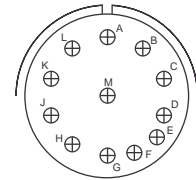
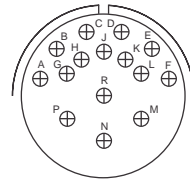
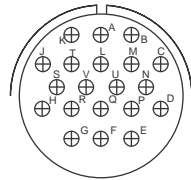
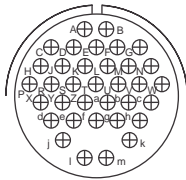
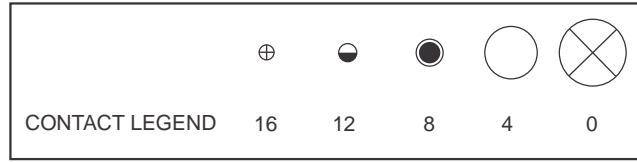

Insert arrangement 28-15
 Service rating A
 Number of contacts 35
 Contact size 16
 Premating contact M

28-16
 A
 20
 16
 F

*28-17
 R=B;M,N,P=D;A to L=A
 15
 16
 N

28-18
 M=C;G,H,J,K,L=D;A,B=ABal.=Inst.
 12
 16
 -

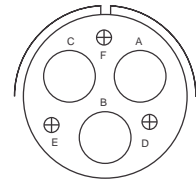
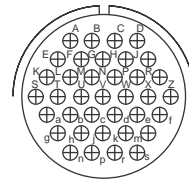
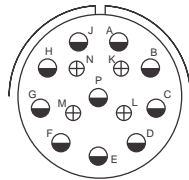
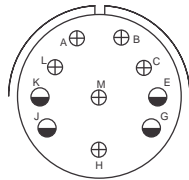

Insert arrangement 28-19
 Service rating H,M=B;A,B=D;Bal.=A
 Number of contacts 4 6
 Contact size 12 16
 Premating contact H

28-20
 A
 10 4
 12 16
 E

28-21
 A
 37
 16
 A

28-22
 D
 3 3
 4 16
 -

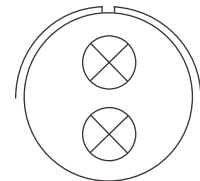
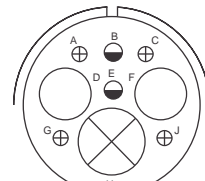
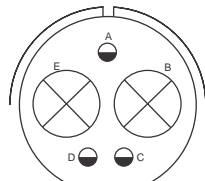
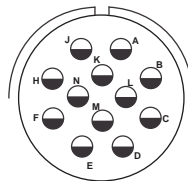

Insert arrangement 28-51
 Service rating D
 Number of contacts 12
 Contact size 12
 Premating contact -

32-1
 A=E;B,C,D,E=A
 2 3
 0 12
 -

*32-3
 D
 1 2 2 4
 0 4 12 16
 -

32-5
 D
 2
 0

*Not tooled up, can be tooled up on request. Contact Factory.

Front face of pin insert or rear of socket insert illustrated

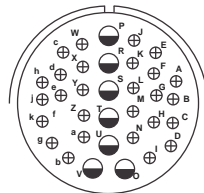
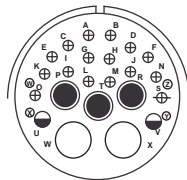

Insert arrangement
Service rating
Number of contacts
Contact size
Premating contact

32-6
A
16 2 3 2
16 12 8 4
-

32-7
INST, A
4 24 7
16 12
-

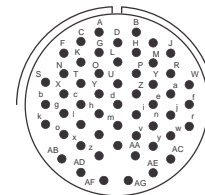
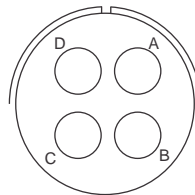
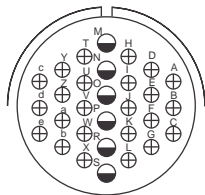

Insert arrangement
Service rating
Number of contacts
Contact size
Premating contact

32-8
A
6 24
12 16
S

32-17
D
4
4
-

32-22
A
54
16
-

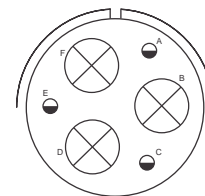
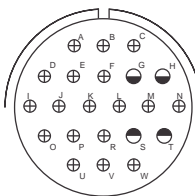
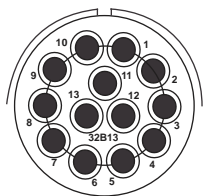

Insert arrangement
Service rating
Number of contacts
Contact size
Premating contact

32B-13
D
13
8
-

*36-1
D
4 18
12 16
-

36-3
D
3 3
0 12
-

*Not tooled up, can be tooled up on request. Contact Factory.

Insert Arrangements

Front face of pin insert or rear of socket insert illustrated

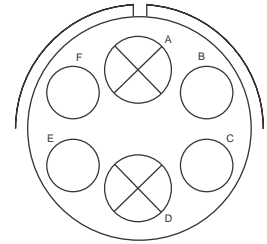
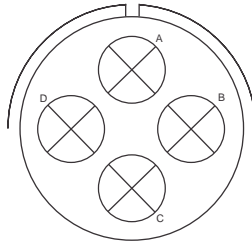
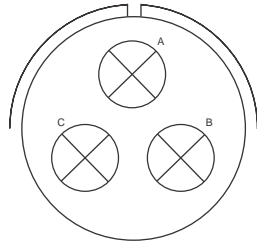
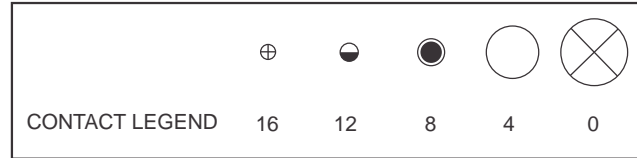

Insert arrangement
Service rating
Number of contacts
Contact size
Premating contact

36-4
A=D; B, C=A
3
0
-

36-5
A
4
0
-

36-6
A
2 4
0 4
-

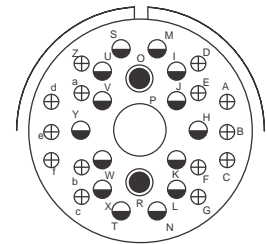
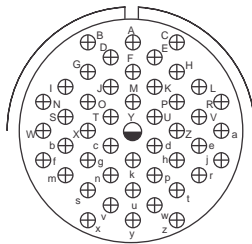
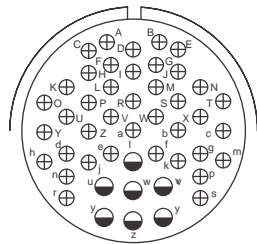

Insert arrangement
Service rating
Number of contacts
Contact size
Premating contact

*36-7
A
7 40
12 16
x or y

*36-8
A
1 46
12 16
Y

*36-9
A
1 2 14 14
4 8 12 16
P

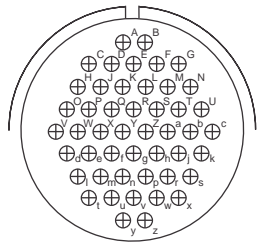
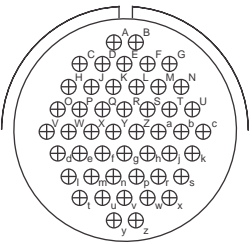
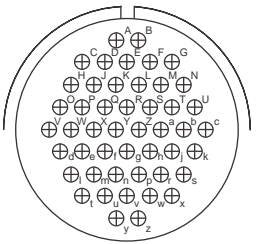

Insert arrangement
Service rating
Number of contacts
Contact size
Premating contact

36-10
A
48
16
A

100°rotation
of 36-10
*36-11
A
48
16
A

250°rotation
of 36-10
*36-12
A
48
16
A

*Not tooled up, can be tooled up on request. Contact Factory.

Insert Arrangements

Front face of pin insert or rear of socket insert illustrated

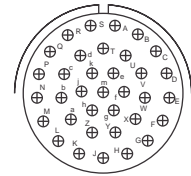
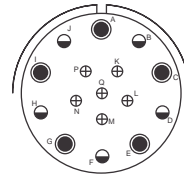
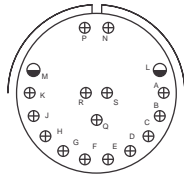
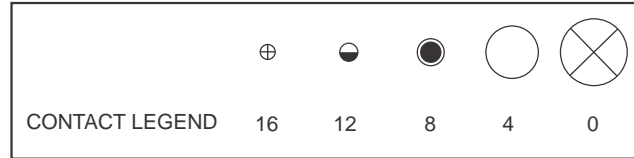

Insert arrangement
Service rating
Number of contacts
Contact size
Premating contact

*36-13
N,P,Q=E;Bal.=A
2 15
12 16
-

*36-14
D
5 5 6
8 12 16
-

*36-15
M=D;Bal=A
35
16
J

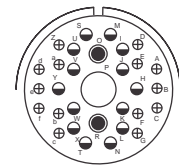
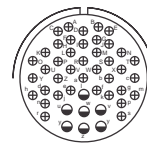
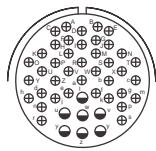

100°rotation
of 36-7

250°rotation
of 36-7

100°rotation
of 36-9

Insert arrangement
Service rating
Number of contacts
Contact size
Premating contact

*36-16
A
7 40
12 16
x or y

*36-17
A
7 40
12 16
x or y

*36-18
A
1 2 14 16
4 8 12 16
-

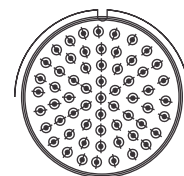
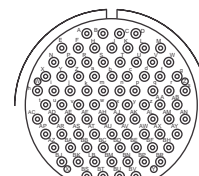
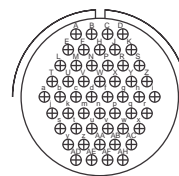
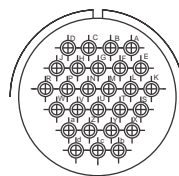
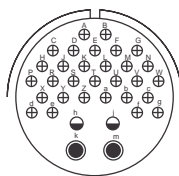

Insert arrangement
Service rating
Number of contacts
Contact size
Premating contact

*36-20
A
2 2 30
8 12 16
k

36-46
A
27
16
-

36-52
A
52
16
-

40-56
A
85
16
-

40-63
A
61
16
-

*Not tooled up, can be tooled up on request. Contact Factory.

Wall Mounting Receptacle MS3100/MS4100

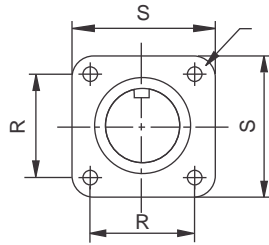
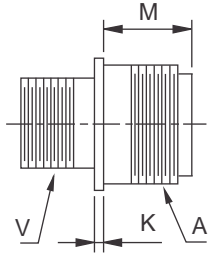

MOUNTING HOLES
 4.39 DIA. FOR SIZE 32 AND 36
 3.73 DIA. FOR SIZE 24 AND 28
 3.05 DIA. FOR ALL OTHER SIZES
 4.55 DIA. FOR 40 SIZE

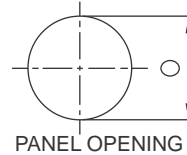

All dimensions are in mm

Connector Size	A Thread in inches	K	M	O	R	S	V Thread in inches
10SL	5/8-24 UNEF	1.98	14.29	20.62	18.25	25.68	5/8-24 NEF
12S	3/4-20 UNEF	1.98	14.29	20.62	20.64	27.76	11/16-24NEF
12	3/4-20 UNEF	1.98	19.05	20.62	20.64	27.76	11/16-24NEF
14S	7/8-20 UNEF	1.98	14.29	23.82	23.02	30.43	3/4-20 UNEF
14	7/8-20 UNEF	1.98	19.05	23.82	23.02	30.43	3/4-20 UNEF
16S	1-20 UNEF	1.98	14.29	26.97	24.61	32.82	7/8-20 UNEF
16	1-20 UNEF	3.17	19.05	26.97	24.61	32.82	7/8-20 UNEF
18	1 1/8-18 UNEF	3.17	19.05	30.17	26.99	35.07	1-20 UNEF
20	1 1/4-18 UNEF	3.17	19.05	33.32	29.37	38.38	1 1/8-18 NS
22	1 3/8-18 UNEF	3.17	19.05	36.52	31.75	41.55	1 1/4-18 NEF
24	1 1/2-18 UNEF	3.17	20.64	39.67	34.92	44.70	1 3/8-18 NEF
28	1 3/4-18 UNS	3.17	20.64	46.02	39.69	51.08	1 5/8-18 NEF
32	2.00-18 UNS	3.17	22.25	53.0	44.45	57.15	1 7/8-16UN
36	2 1/4-16 UN	3.17	22.22	58.72	49.21	63.78	2 1/16-16UN
40	2 1/2-16 UN	3.45	22.22	62.00	55.58	69.85	2 5/16-16 UN

Cable Connecting Receptacle MS3101/MS4101

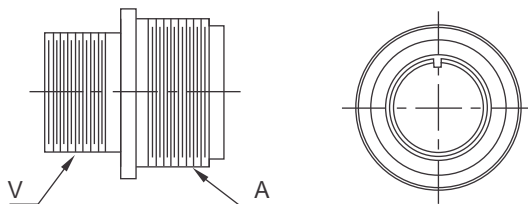

All dimensions are in mm

Connector Size	A Thread in inches	V Thread in inches
10SL	5/8-24 UNEF	5/8-24 NEF
12S	3/4-20 UNEF	11/16-24 NEF
12	3/4-20 UNEF	11/16-24 NEF
14S	7/8-20 UNEF	3/4-20 UNEF
14	7/8-20 UNEF	3/4-20 UNEF
16S	1-20 UNEF	7/8-20 UNEF
16	1-20 UNEF	7/8-20 UNEF
18	1 1/8-18 UNEF	1-20 UNEF
20	1 1/4-18 UNEF	1 1/8-18 NS
22	1 3/8-18 UNEF	1 1/4-18 NEF
24	1 1/2-18 UNEF	1 3/8-18 NEF
28	1 3/4-18 UNS	1 5/8-18 NEF
32	2-18 UNS	1 7/8-16UN
36	2 1/4-16 UN	2 1/16-16UN
40	2 1/2-16 UN	2 5/16-16 UN

Box Mounting Receptacle MS3102/MS4102

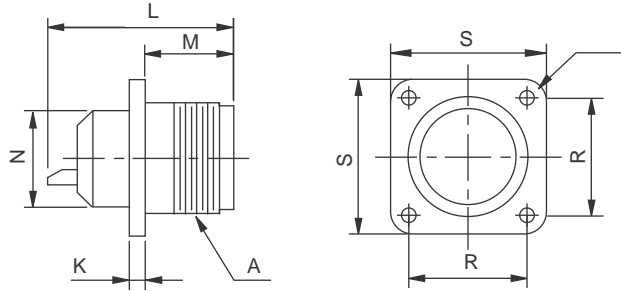

MOUNTING HOLES
 4.39 DIA. FOR SIZE 32 AND 36
 3.73 DIA. FOR SIZE 24 AND 28
 3.05 DIA. FOR ALL OTHER SIZES
 4.55 FOR 40 SIZE

All dimensions are in mm

Connector Size	A Thread in inches	K	L	M	N	R	S
10SL	5/8-24 UNEF	1.98	30.18	13.89	15.87	18.25	25.68
12S	3/4-20 UNEF	1.98	30.18	14.28	17.46	20.64	28.04
12	3/4-20 UNEF	1.98	41.28	19.05	17.46	20.64	28.04
14S	7/8-20 UNEF	1.98	30.18	14.28	19.05	23.02	30.43
14	7/8-20 UNEF	1.98	41.28	19.05	19.05	23.02	30.43
16S	1-20 UNEF	1.98	30.18	14.28	22.22	24.61	32.82
16	1-20 UNEF	3.17	41.28	19.05	22.22	24.61	32.82
18	1 1/8-18 UNEF	3.17	49.28	19.05	25.40	26.99	35.08
20	1 1/4-18 UNEF	3.17	49.28	19.05	28.57	29.37	38.38
22	1 3/8-18 UNEF	3.17	49.28	19.05	31.75	31.75	41.55
24	1 1/2-18 UNEF	3.17	49.28	20.64	34.92	34.92	44.73
28	1 3/4-18 UNS	3.17	49.28	20.64	41.27	39.69	51.08
32	2-18 UNS	3.17	49.28	22.22	48.26	44.45	57.15
36	2 1/4-16 UN	3.17	49.28	22.22	53.97	49.21	63.78
40	2 1/2-16 UN	3.45	49.28	22.22	58.25	55.58	69.85

Straight Plug MS3106T/MS4106T

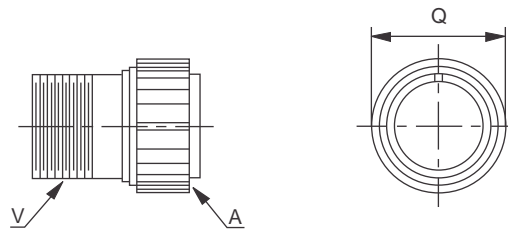

All dimensions are in mm

Connector Size	A Thread in inches	Q max	V Thread in inches
10SL	5/8-24 UNEF	19.05	5/8-24 NEF
12S	3/4-20 UNEF	19.84	11/16-24NEF
12	3/4-20 UNEF	19.84	11/16-24NEF
14S	7/8-20 UNEF	22.22	3/4-20 UNEF
14	7/8-20 UNEF	22.22	3/4-20 UNEF
16S	1-20 UNEF	25.40	7/8-20 UNEF
16	1-20 UNEF	25.40	7/8-20 UNEF
18	1 1/8-18 UNEF	28.57	1-20 UNEF
20	1 1/4-18 UNEF	31.75	1 1/8-18 NS
22	1 3/8-18 UNEF	34.92	1 1/4-18 NEF
24	1 1/2-18 UNEF	38.10	1 3/8-18 NEF
28	1 3/4-18 UNS	44.45	1 5/8-18 NEF
32	2-18 UNS	51.75	1 7/8-16UN
36	2 1/4-16 UN	57.15	2 1/16-16UN
40	2 1/2-16 UN	63.50	2 5/16-20 UN

Note - Both versions, straight and diamond knurling available on coupling ring. For details, contact factory.

MS3108A/MS4108A Supplied Without Grommet
MS3108R/4108R Supplied With Grommet

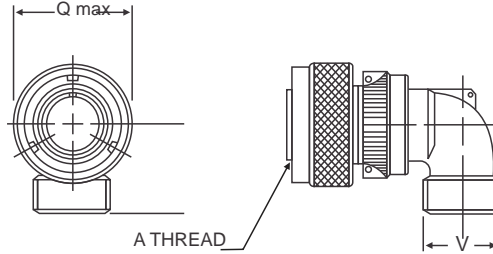

All dimensions are in mm

Connector Size	A Thread in inches	Q max	V Thread in inches
10SL	5/8-24 UNEF	19.05	5/8-24 NEF
12S	3/4-20 UNEF	19.84	11/16-24 NEF
12	3/4-20 UNEF	19.84	11/16-24 NEF
14S	7/8-20 UNEF	22.22	3/4-20 UNEF
14	7/8-20 UNEF	22.22	3/4-20 UNEF
16S	1-20 UNEF	25.40	7/8-20 UNEF
16	1-20 UNEF	25.40	7/8-20 UNEF
18	1 1/8-18 UNEF	28.57	1-20 UNEF
20	1 1/4-18 UNEF	31.75	1 1/8-18 NS
22	1 3/8-18 UNEF	34.92	1 1/4-18 NEF
24	1 1/2-18 UNEF	38.10	1 3/8-18 NEF
28	1 3/4-18 UNS	44.45	1 5/8-18 NEF
32	2-18 UNS	51.75	1 29/32-18 NS
36	2 1/4-16 NS	57.15	2 1/16-20 UNS
40	2 1/2-16 UN	63.50	2 5/16-16 UN

Note - Both versions, straight and diamond knurling available on coupling ring. For details, contact factory.

Other Accessories
Dummy receptacle
MS3105

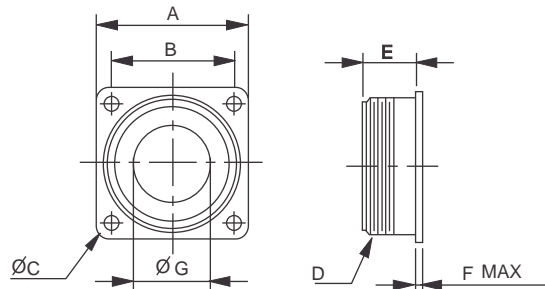

All dimensions are in mm

Part number (see note)	A	B	C	D Thread in inches	E	F max.	G
MS-3105-10S	25.4	18.26	3.05	5/8-24	14.27	3.96	8.20
MS-3105-12S	27.79	20.62	3.05	3/4-20	14.27	3.96	11.43
MS-3105-12	27.79	20.62	3.05	3/4-20	19.05	3.96	11.43
MS-3105-14S	30.17	23.01	3.05	7/8-20	14.27	3.96	13.36
MS-3105-14	30.17	23.01	3.05	7/8-20	19.05	3.96	13.36
MS-3105-16S	32.54	24.61	3.05	1-20	14.27	3.96	16.41
MS-3105-16	32.54	24.61	3.05	1-20	19.05	3.96	16.41
MS-3105-18	34.92	26.97	3.05	1 1/8-18	19.05	5.16	18.03
MS-3105-20	38.10	29.36	3.05	1 1/4-18	19.05	5.16	23.54
MS-3105-22	41.27	31.75	3.05	1 3/8-18	19.05	5.16	25.93
MS-3105-24	44.45	34.92	3.73	1 1/2-18	20.62	5.16	29.21
MS-3105-28	50.8	39.67	3.73	1 3/4-18	20.62	5.16	34.67
MS-3105-36	63.5	49.22	4.39	2 1/4-16	22.2	9.11	46.56

Note: The dash number also indicates shell size.

3 106A/4106A

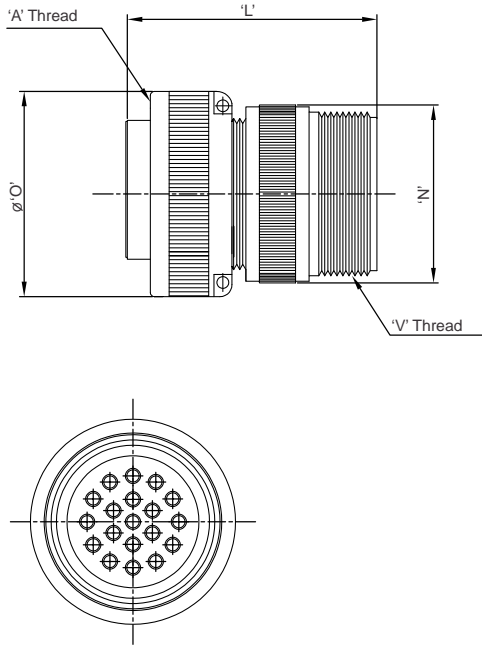

SIZE	'O'	'L'	'N'	'A'-THD	'V'-THD
10SL	22.23	38.89	19.13	5/8-24UNEF	5/8-24UNEF
12S	25.40	42.88	19.84	3/4-20UNEF	5/8-24UNEF
12	26.46	52.37	19.84	3/4-20UNEF	5/8-24UNEF
14S	28.30	42.88	22.70	7/8-20UNEF	3/4-20UNEF
16S	31.40	42.88	26.10	1-20UNEF	7/8-20UNEF
16	31.40	52.37	26.10	1-20UNEF	7/8-20UNEF
18	33.70	52.37	29.30	1 1/8-18NEF	1-20UNEF
20	36.80	55.57	33.00	1 1/4-18NEF	1 3/16-18UNEF
22	40.00	55.57	36.00	1 3/8-18NEF	1 3/16-18UNEF
24	43.50	58.72	38.10	1 1/2-18NEF	1 7/16-18UNEF
28	49.80	58.72	44.53	1 3/4-18NS	1 7/16-18UNEF
32	56.00	61.93	51.24	2-18UNS	1 3/4-18UNEF
36	62.50	61.93	57.23	2 1/4-16UN	2-18UN

3106F/4106F

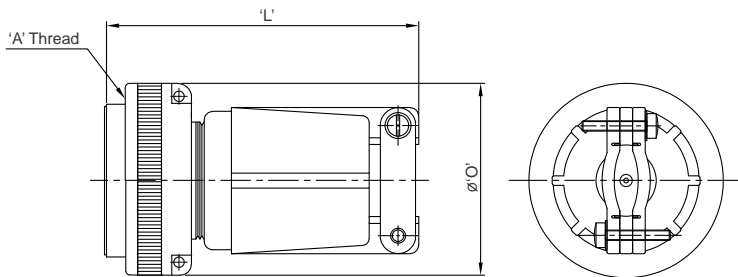

SHELL SIZE	'O'	'L'	'A' THREAD
10SL	22.23	58.72	5/8-24UNEF
12S	25.40	58.72	3/4-20UNEF
12	26.49	67.46	3/4-20UNEF
14S	28.30	58.72	7/8-20UNEF
16S	31.40	58.72	1-20UNEF
16	31.40	67.46	1-20UNEF
18	33.70	70.63	1 1/8-18NEF
20	36.80	70.63	1 1/4-18NEF
22	40.00	70.63	1 3/8-18NEF
24	43.50	75.41	1 1/2-18NEF
28	49.80	76.98	1 3/4-18NS
32	56.00	82.55	2-18 UNS
36	62.50	83.33	2 1/4-16UN

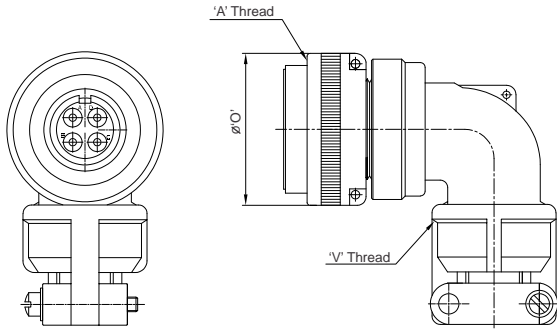

SHELL SIZE	'O'	'A' THREAD	'V' THREAD
10SL	22.23	5/8-24UNEF	5/8-24UNEF
12S	25.40	3/4-20UNEF	5/8-24UNEF
12	26.49	3/4-20UNEF	5/8-24UNEF
14S	28.30	7/8-20UNEF	3/4-20UNEF
16S	31.40	1-20UNEF	7/8-20UNEF
16	31.40	1-20UNEF	7/8-20UNEF
18	33.70	1 1/8-18NEF	1-20UNEF
20	36.80	1 1/4-18NEF	1 3/16-18UNEF
22	40.00	1 3/8-18NEF	1 3/16-18UNEF
24	43.50	1 1/2-18NEF	1 7/16-18UNEF
28	49.80	1 3/4-18NS	1 7/16-18UNEF
32	56.00	2-18UNS	1 3/4-18UNEF
36	62.50	2 1/4-16UN	2-18UN

M S3057/A STYLE

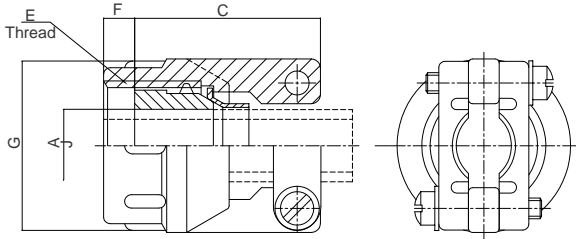

Part Number Development

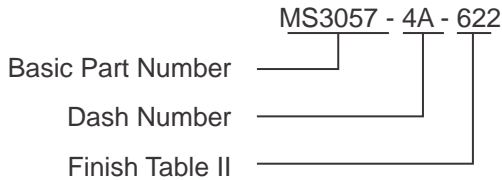

TABLE I

PART NO.	SHELL SIZE	'A' ±0.2	'B' ±0.2	'C'	'V'-THD
MS3057-3A	8	20.80	20.60	6.35	1/2-28
MS3057-4A	10	20.30	23.30	7.93	5/8-24
MS3057-6A	14	22.50	27.00	11.12	3/4-20
MS3057-8A	16	24.40	28.90	14.27	7/8-20
MS3057-10A	18	23.70	32.20	15.87	1-20
MS3057-12A	20, 22	23.60	37.80	19.05	1 3/16-18
MS3057-16A	24,28	26.00	43.40	23.82	1 7/16-18
MS3057-20A	32	27.70	52.10	31.75	1 3/4-18
MS3057-24A	36	29.20	57.30	34.92	2-18
MS3057-28A	40	42.70	68.30	41.27	2 1/4-16

TABLE II

FINISH CODE	FINISH (BODY & CLAMP)	FINISH (SCREW & WASHER)	REMARK
—	CD OLIVE DRAB	CD OLIVE DRAB	—
-622	ZN CO GREEN	ZN CO GREEN	ROHS COMPLAINT
-624	ZN CO BLACK	ZN CO BLACK	ROHS COMPLAINT
-A23	ELECTROLESS NICKEL	ELECTROLESS NICKEL	ROHS COMPLAINT
-626	ZN NICKEL BLACK	ZN NICKEL BLACK	ROHS COMPLAINT

MS3057/C STYLE

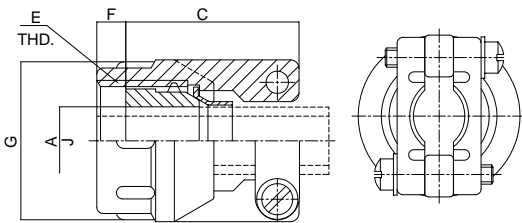

CONN. SIZE	MS. P/NO.	Ø'A' MAX. CABLE	Ø'J' CLOSED	'C' MAX.	'E' THREAD CLASS 2B	'F' MIN.	Ø'G' ±0.41	'H' MAX.	
10SL 12, 12S	MS3057-4C	7.67	2.39	23.82	0.625-24UNEF	9.52	21.44	23.01	
14, 14S	MS3057-6C	10.87	5.84	23.82	0.750-20UNEF	↓	24.61	26.19	
16, 16S	MS3057-8C	13.08	8.02	23.82	0.875-20UNEF		27.79	28.57	
18	MS3057-10C	15.60	9.60	25.81	1.000-20UNEF		30.96	31.34	
20, 22	MS3057-12C	18.74	11.30	26.19	1.1875-18UNEF	↓	35.71	37.69	
24, 28	MS3057-16C	23.52	15.52	28.98	1.4375-18UNEF	9.52	42.06	42.44	
32	MS3057-20C	30.48	23.42	33.73	1.750-18UNS	11.12	50.8	55.57	
36	MS3057-24C	34.62	23.42	38.89	2.000-18UNS	12.70	57.15	59.54	
40	MS3057-28C	40.92	29.97	38.89	2.250-16UN	12.70	63.50	65.89	

HOW TO ORDER

Military #	MS25042	-10	D
Amphenol #	A25042	-10	D
BASIC NO.	DASH NO.	FINISH	
	REFER TABLE-1	REFER TABLE-2	

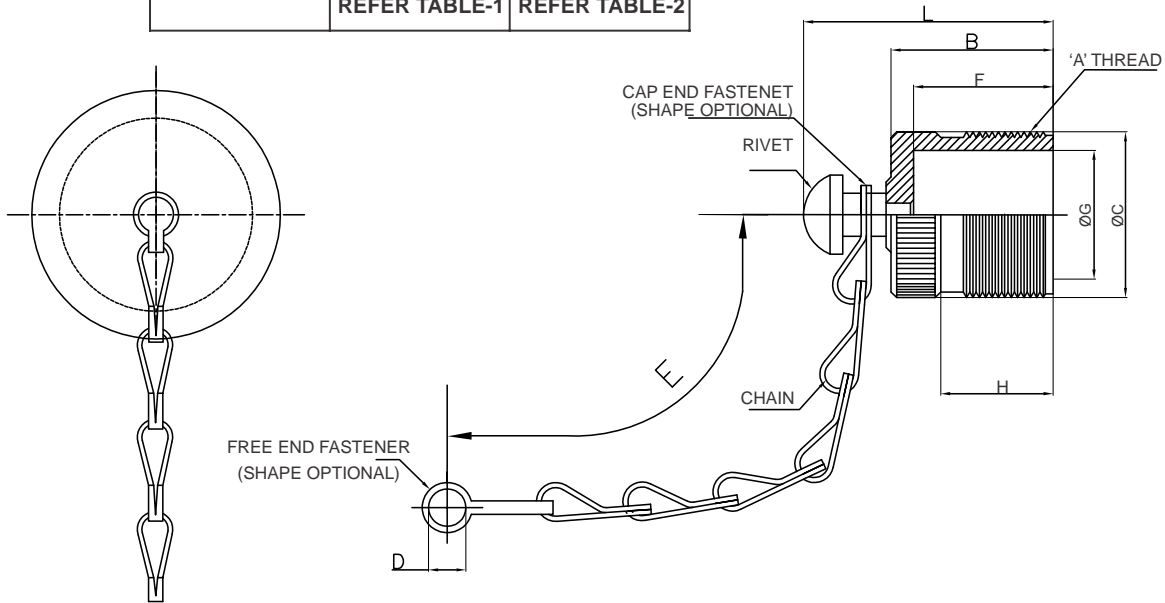

Table-1

Dash No. (-)	Coupling Shell Size Ref.	A Thread	'B' Max.	'C' Max. Dia.	ϕD $\begin{matrix} +.010 \\ (0.27) \\ -.005 \\ (0.12) \end{matrix}$	E ± 1 Link	F	G Dia	H Min	L Max
8	8S	.500-28 UNEF-2A	.656 (16.7)	.562 (14.3)	.156 (4.0)	4.000 (101.6)	.562 (14.3)	.375 (9.5)	.530 (13.5)	.969 (24.6)
10	10S,10SL	.625-24 UNEF-2A		.687 (17.4)						.469 (11.9)
12	12,12SL	.750-20 UNEF-2A		.812 (20.6)						.562 (14.3)
14	14,14SL	.875-20 UNEF-2A		.937 (23.8)			4.500 (114.3)			.688 (17.5)
16	16,16SL	1.000-20 UNEF-2A		1.062 (27.0)						.812 (20.5)
18	18	1.125-20 UNEF-2A		1.187 (30.1)						.938 (23.8)
20	20	1.250-18 UNEF-2A		1.312 (33.3)			5.000 (127.0)			1.062 (27.0)
22	22	1.375-18 UNEF-2A		1.437 (36.5)		.187 (4.7)		.750 (19.1)		1.188 (30.2)
24	24	1.500-18 UNEF-2A		1.562 (39.7)			5.500 (139.7)			1.312 (33.3)
28	28	1.750-18 UNS-2A	.844 (21.4)	1.812 (46.0)						1.531 (38.9)
32	32	2.000-18 UN-2A		2.062 (52.4)				1.781 (45.2)		
36	36	2.250-16 UN-2A		2.312 (58.7)		7.750 (196.9)		2.000 (50.8)		
40	40	2.500-16 UN-2A		2.562 (65.1)	.218 (5.5)			2.250 (57.2)		
44	44	2.750-16 UN-2A		2.812 (71.4)				2.500 (63.5)		
48	48	3.000-16 UN-2A		3.062 (77.8)				2.750 (69.9)		

Table-3 Material

Cover -Aluminum Alloy
Chain - Stainless Steel Sash Chain Passivated

Table-2 Finish

Finish Code	Finish Description
D	Cadmium Olive Drab Over Electroless Nickel
DA	Black Anodize

HOW TO ORDER

Military #	MS25043	-10	D
Amphenol #	A25043	-10	D
BASIC NO.	DASH NO.	FINISH	
	REFER TABLE-1	REFER TABLE-2	

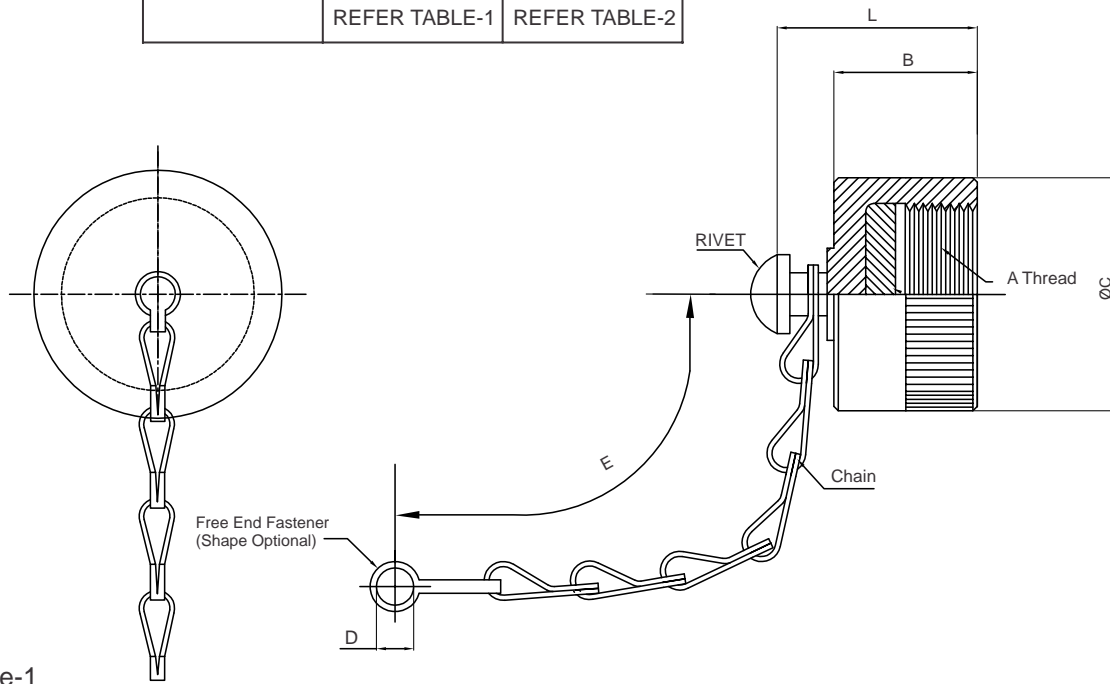

Table-1

Dash No. (-)	Coupling Shell Size Ref.	A Thread	'B' Max.	'C' Max. Dia.	ϕD (0.27 -0.005 0.012)	E ±1 Link	L Max	
8	8S	.500-28 UNEF-2B	4.69 (11.9)	.688 (17.5)	.140 (3.6)	4.000 (101.6)	.750 (19.1)	
10	10S,10SL	.625-24 UNEF-2B		.813 (20.7)				
12	12,12SL	.750-20 UNEF-2B		1.000 (25.4)				
14	14,14SL	.875-20 UNEF-2B		1.125 (28.6)				
16	16,16SL	1.000-20 UNEF-2B		1.188 (30.2)				
18	18	1.125-20 UNEF-2B		1.344 (34.1)				
20	20	1.250-18 UNEF-2B		1.469 (37.3)		.171 (4.5)		5.000 (127.0)
22	22	1.375-18 UNEF-2B		1.594 (40.5)				
24	24	1.500-18 UNEF-2B		1.719 (43.7)				5.500 (139.7)
28	28	1.750-18 UNS-2B		1.969 (50.0)				
32	32	2.000-18 UN-2B	2.219 (56.4)	.187 (4.7)	7.750 (196.9)	812 (20.6)		
36	36	2.250-16 UN-2B	2.469 (62.7)					
40	40	2.500-16 UN-2B	2.718 (69.0)					
44	44	2.750-16 UN-2B	2.969 (75.4)					
48	48	3.000-16 UN-2B	3.188 (81.0)					
			3.188 (81.0)					

Table-3 Material

Cover - Aluminum Alloy
Chain - Stainless Steel Sash Chain Passivated
Gasket - Silicon Elastomer Disk

Table-2 Finish

Finish Code	Finish Description
D	Cadmium Olive Drab Over Electroless Nickel
DA	Black Anodize

Neoprene Sleeve

MS3420

Rubber bushing. Protects wire bundles and unjacketed cables from possible damage by cable clamp.

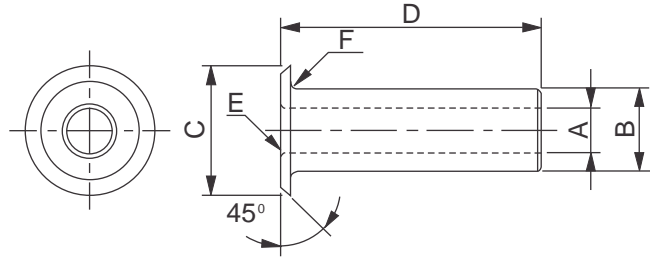

All dimensions are in mm

Part number	A	B	C	D	E Rad in inches	F Rad in inches
MS-3420-3	3.30	5.33	9.50	73.02	0.79	0.79
MS-3420-4	5.59	7.67	12.70	69.85	0.79	0.79
MS-3420-6	7.92	10.84	15.59	66.67	0.79	1.59
MS-3420-8	11.10	14.02	18.77	63.50	1.59	1.59
MS-3420-10	14.27	15.62	21.94	60.32	1.59	1.59
MS-3420-12	15.87	18.80	26.23	56.20	1.59	1.59
MS-3420-16	19.05	23.54	26.39	53.97	1.59	1.59
MS-3420-20	23.80	31.50	40.41	50.80	1.59	1.59
MS-3420-24	31.75	34.67	46.79	47.62	1.59	1.59

Plain Flat Gasket

For MS and 97B flange mounted receptacles

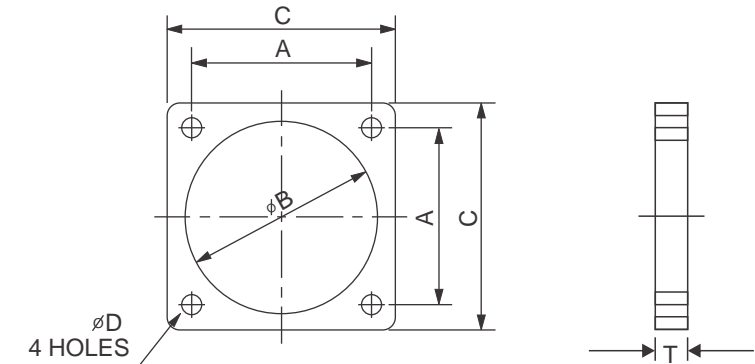

All dimensions are in mm

Part number	Shell size	A max	B	C	D	T
MS-101000	10SL	18.26	15.90	25.40	4.35	1.5
MS-108686	12S & 12	20.62	19.05	27.80	4.35	1.5
MS-101001	14S & 14	23.01	22.20	30.15	4.35	1.5
MS-101002	16S & 16	24.61	25.40	32.50	4.35	1.5
MS-101003	18	27.00	28.57	34.90	5.15	1.5
MS-101004	20	29.36	31.75	38.10	5.15	1.5
MS-101005	22	31.75	34.90	41.20	5.15	1.5
MS-108687	24	34.90	38.10	44.45	5.15	1.5
MS-101006	28	39.70	44.45	50.80	5.15	1.5
MS-108688	32	44.45	50.80	57.15	5.55	1.5
MS-101007	36	49.22	55.57	63.50	5.55	1.5
MS-110831	40	55.77	61.92	69.85	5.55	1.5

Crimp Contact

Contacts for connectors are machined from copper alloys and silver plated for maximum corrosion resistance, with a minimum millivolt drop and a maximum current carrying capacity; the size 16 and 12 socket contacts are of the closed entry design. Gold plated contacts are also available.

Part Number For Crimp Contacts only*	Pin/Socket	Mating End Size	Wire Barrel Size	Allowable Wire size	Test Current*** Amps	Insertion/Removal Tool
MS-106433	Pin	16 Short†	16	16	13	97B-IR-16
MS-108456	Socket			18	10	
MS-108295	Pin	16 Long	16	60	7.5	97B-IR-16
MS-108457	Socket			22**	5	
MS-108388	Pin	12	12	16	13	97B-IR-12
MS-110262	Socket			18	10	
MS-108386	Pin	8	8	20	7.5	97B-IR-8
MS-108387	Socket			22**	5	
MS-108384	Pin	4	4	12	23	97B-IR-4
MS-111878	Socket			14	17	
MS-112067	Pin	0	0	8	46	97B-IR-0
MS-112068	Socket			10**	33	
				4	80	
				6**	60	
				0	150	
				1	125	
				2**		

* Solder contacts are not sold as separate items. Part numbers shown here are for crimp contacts only.

** When using wire adapter sleeve shown.

*** Contact rating as stated are test ratings only. The connector may not withstand full rated current through all contacts continuously. Please note that the electrical data given is not an establishment of electrical safety factors. This is left entirely in the designer's hands as he can best determine which peak voltage, switching surges, transients, etc. can be expected in a particular circuit.

MS Connectors Application tools

When proprietary crimp contacts are employed rather than the standard MS approved solder contacts, the following application tools are recommended for use.

There is a possibility of additional crimping tools other than those included being available at present or in the future for this specific application.

TOOLING CHART

Crimping Tool	Positioner/Turret
M22520/1-01	*
M22520/1-01	*
**	**
**	**
**	**

* Use Daniels Turret TH29-1 or Astro Tool Co. Turret 616266

** For appropriate crimp tool and positioner refer to Pico Crimping Tool Co.

† Tools used with Arbor Press 11-7364

To obtain the specific connector required, write down the connector number from the typical example below. Only inserts shown in the availability chart shown on page 7 can be specified. Connectors are delivered with protective plastic dust covers. Include pre-mating contact designation only if pre-mating contact is required. The second letter in the pre-mating contact designation stands for the actual contact position.

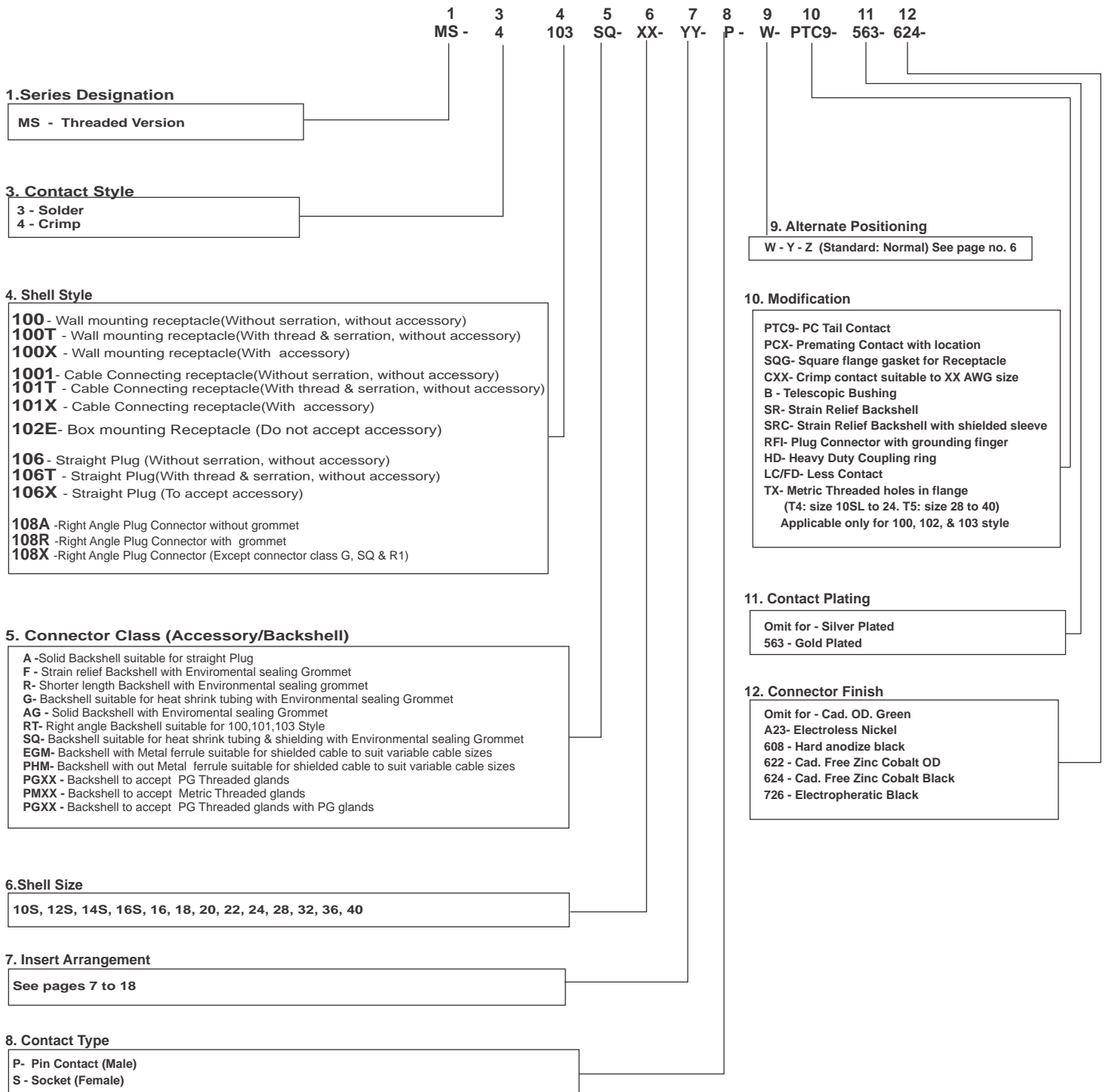

Notice : All information, including illustrations given herein is believed to be accurate at the time of printing. In lieu of design advances, Amphenol reserves the right to change specifications without notice. This publication ACAMS02 04/18 MS Series Connectors supercedes all existing Amphenol literature on MS Series Connectors.

NORTH AMERICA

Sales & Product Support

Amphenol PCD
72 Cherry Hill Drive
Beverly, MA 01915 USA
Tel: +1-978-624-3400
Fax: +1-978-927-1513
info@amphenolpcd.com
www.amphenolpcd.com
www.backshellworld.com

Amphenol Aerospace Operations
40-60, Delaware Avenue
Sidney, NY 13838-1395
Tel: +1-607-563-5011
Fax: +1-607-563-5357

Amphenol Canada
Meford Drive
Scarborough,
ON M1B 2X6
Tel: +416-291-4401
Fax: +416-292-0647

Amphenol Fiber Systems International
1300 Central Expressway North
Suite 100 Allen, Texas 75013, USA
Tel: +1-214-547-2400
Fax: +1-214-547-9344

EUROPE

France

Amphenol Socapex S.A.S.
948, Promenade de l'Arve
Bp29, Thyez Cedex
74311, France
Tel: +33-4-5089-2800
Fax: +33-4-5096-1941

United Kingdom

Amphenol Limited
Thanet Way, Whitstable
Kent CT5 3JF, England
Tel: +44-1227-773-200
Fax: 44-1227-276-571

Germany

Amphenol-Air LB GmbH
Am Kleinbahnhof 4
Saarlouis
D-66740, Germany
Tel: 49-6831-9810-00
Fax: 49-6831-9810-30

Italy

Amphenol Military &
Aerospace Operations-
European Sales Operations
Via Barbaiana 5
20020 Lainate
Milano,
Italy+39 02 932 541

Center & East Europe

Amphenol Austria
Wiener Gasse 68
2380 Perchtoldsdorf
Tel: +43-699-10396071
Fax: +43 699 40396071

Amphenol Air-LB
Immeuble Le Doublon
11, Avenue Dobonnet
Courbevoie-Cedex
92407, France
Ph: +33-1-4905-3000
Fax: +33-1-4905-3043

Spain

Amphenol Iberica
Edificio Burgosol Oficina
N 55 C/Comunidad de
Madrid 35 bis -
Las Rozas (Madrid)
Tel: +34-91-6407302
+34-91-6407306
Fax: +34-91-6407307

Holland

Amphenol Benelux
Zadelmaker 121
NL-2401 PD Alphen
aan den Rijn Holland
Tel: +31-172-444903
Fax: +31-172 240254

Sweden

Amphenol
Industrial and Military &
Aerospace
Nordic & Baltic
Military Phone/
Mobile+46702129200
Industrial +46 767909560

ASIA

India

Amphenol Interconnect India Pvt. Ltd.
105 Bhosari Industrial Area
Pune-411026, India
Tel: +9120-3068-8305
Fax: +9120-2712-9158

Japan

Amphenol Japan
471-1, Deba, Ritto City
Shiga 520-3041, Japan
Tel: +81-77-553-8501
Fax: +81-77-551-2200

Singapore

Amphenol East Asia Ltd.
72 Bendemeer Road
03-33 Luzerne
Singapore 339 941
Tel: 65-6294-2128
Fax: 65-6294-3522

China

Amphenol PCD Shenzhen
3/F Building, A4 Songbai
Industrial Park
East Road of Minghuan
Gongming Town, Baon District
Shenzhen, China
Tel: +86-755-8173-8000
Fax: +86-755-8173-8180

Amphenol Interconnect India Pvt. Ltd.
61 Electronics City
Bangalore-560 100, India
Ph: +9180-2852-3838
Fax: +9180-2852-0418

Korea

Amphenol Daeshin Electronics
558 SoSa, SongNae, Bucheon-City
Kyunggi-Do, Korea 420-130
Tel: +82-32-610-3800
Fax: +92-32-673-2507

ROW

Australia

Amphenol Australia Pty Ltd
2 Fiveways Boulevard
Keysborough
VIC 3173
Ph: +61-3-8796-8888
Fax: +61-3-8796-8801

Africa

Amphenol South Africa
30 Impala Road
2196 Sandton-Chistlehurst
South Africa
Tel: +27-11-783-9517
Fax: +27-11-783-9519

Russia

Amphenol Russia
8-2 Yaroslavskaja Str
129164 Moscow, Russia
Tel: +7-495-937-6341
Fax: +7-495-937-6319

Argentina

Amphenol Argentina
Avenida Callao 930
2nd Floor, Office B Plaza
C1023AAP Buenos Aires
Argentina
Tel: 54-11-4815-6886
Fax: 54-11-4814-5779

Israel

Amphenol Bar-Tec Ltd.
www.bar-tec.com
3 Hagavish st
POB 2479 Kfar-Saba 44641
Israel+972-9-7644100

Turkey

Amphenol Turkey & Middle East
Sun Plaza Kat:19
Maslak Mah. Bilim Sok.No:5
34398 Sisli - Istanbul
Tel: +90-212-335-2501
Fax: +90-212-335-2500

Brazil

Amphenol do Brasil Ltda
Rua Diogo Moreira 132
CEP 05423-010
Sao Paulo-SP, Brazil
Tel: +55-11-3815-1003
Fax: +55-11-3815-1629

Amphenol

A Global Company



Pune Operations



Bangalore Operations

Amphenol

Interconnect India Pvt. Ltd.

Manufacturing Locations

Corporate Office & Pune Factory

105, Bhosari Industrial Area,
Pune - 411 026.
Tel.: 91- 20 - 67360302
Fax : 91 - 020 - 67360321
rjohn@amphenol-in.com

Exports

Tel.: 91- 20 - 67360305, 67360353
Email : svpatil@amphenol-in.com

Bangalore Factory

61 Keonics Electronic City
Hosur Road, Bangalore 560 102
Mobile : 91-66790900 /910 /937
Email : shrikantgramopadhye
@amphenol-in.com

Marketing Locations

Marketing Headquarters

Tel.: 91- 020 67360303, 67360304
Fax : 91 - 020 - 67360321
Email : vbhavsar@amphenol-in.com
sales@amphenol-in.com

Western Region

Tel.: 91-20-67360334
Email : sunilp@amphenol-in.com

Northern & Eastern Region

A-421, Pacific Business Park
Plot No. 37/1, Sahibabad Indst. Area
Site IV, Ghaziabad (UP) - 201 010.
Mobile : 91-9910211399
Email : sunily@amphenol-in.com

Southern Region

No. 1115, 22nd Main Road,
11th Cross Sector-1, HSR Layout
Bangalore 560 102
Tel.: 91-80-49530341, 49530345
Fax : 91-80-49538697
Email : kmanoj@amphenol-in.com

Central Region

107, 1st Floor, 'Am Sri Classic',
Sarojinidevi Road, Secunderabad-500 003.
Telefax : 91- 40-66332906
Email : pprasad@amphenol-in.com

www.amphenol-in.com